

# Mobile Crane Grue automotrice

# LTM 1220-5.2

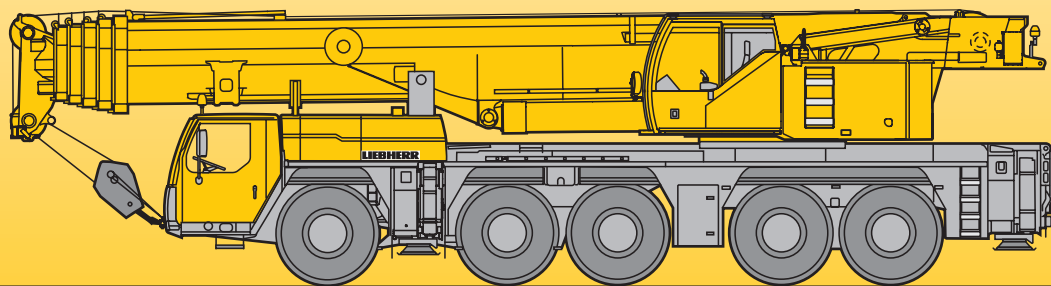



## Technical Data Caractéristiques techniques



# LIEBHERR

# Lifting capacities on telescopic boom

## Forces de levage à la flèche télescopique

44 - 197 ft    163100 lbs  **85%**





ft	ft												ft	
	44 ft	58 ft	72 ft	86 ft	100 ft	114 ft	128 ft	142 ft	156 ft	171 ft	185 ft	197 ft		
10	514	335	308	306	306									10
12	326	326	305	301	298									12
14	294	294	284	276	270	249								14
16	267	267	259	252	247	238								16
18	248	248	241	234	229	222	196							18
21	222	222	216	210	205	202	191	141						21
24	200	200	196	191	187	184	179	139	112					24
27	179	179	179	175	172	168	164	131	111	91				27
30	160	160	165	161	159	155	151	124	107	90.5	73			30
33	137	137	151	149	147	143	140	117	103	87.5	73			33
36	102	102	139	138	137	134	130	110	98.5	84.5	71	59.7		36
39			128	129	128	125	121	103	94	81	69	58.5	48.5	39
45			104	113	113	111	107	92.5	85.5	75	64.5	55.6	46.8	45
51				99	99.5	98	95.5	82.5	78	69	60	52.3	44.6	51
57				83	86	85	83.5	75.5	71	64	56.1	49.2	42.2	57
63					75	74	72.5	70.5	65	59.4	52.6	46.1	39.8	63
69					66	65.5	63.5	64.5	59.7	54.9	49.4	43.4	37.5	69
75					49.8	58.1	57.9	58.2	54.9	51	46.4	41	35.5	75
81						52.1	53.7	52.1	50.2	47.7	43.6	38.6	33.6	81
87						44.3	48.5	46.8	45.3	44.8	41.1	36.3	31.7	87
93							44.1	42.3	41.6	41.5	38.6	34.5	30	93
99							39.8	38.4	39.2	37.6	36.4	32.6	28.5	99
105								35	35.8	34.1	33.8	30.8	27	105
111								33.1	32.8	31.1	31.3	29.4	25.6	111
117								28	30.1	29.2	28.7	28	24.4	117
123									27.7	27.4	26.3	25.8	23.3	123
129									24.8	25.5	24.5	23.7	22.2	129
135										23.6	22.9	21.7	21.1	135
141										21.2	21.3	20	19.9	141
147											19.7	18.3	18.5	147
153											18	16.9	17	153
159												15.5	15.7	159
165												14.3	14.4	165
171													13.2	171
177													12.2	177
183													10.6	183

\* over rear / en arrière

TAB 172259 / 172263

# Lifting capacities on telescopic boom

## Forces de levage à la flèche télescopique











ft	44 ft	58 ft	72 ft	86 ft	100 ft	114 ft	128 ft	142 ft	156 ft	171 ft	185 ft	197 ft	ft
10	335	308	306	306									10
12	326	305	301	298									12
14	294	284	276	270	249								14
16	267	259	252	247	238								16
18	248	241	234	229	222	196							18
21	222	216	210	205	202	191	141						21
24	200	196	191	187	184	179	139	112					24
27	179	179	175	172	168	164	131	111	91				27
30	160	164	161	159	154	149	124	107	90.5	73			30
33	137	149	149	147	140	132	117	103	87.5	73			33
36	102	133	135	132	125	118	110	98.5	84.5	71	59.7		36
39		120	121	119	113	107	102	94	81	69	58.5	48.5	39
45		98	100	99	94.5	89.5	88.5	84	75	64.5	55.6	46.8	45
51			83.5	83.5	80.5	78	76	72	69	60	52.3	44.6	51
57			71.5	71.5	69.5	69.5	66	62.5	61.5	56.1	49.2	42.2	57
63				62	61	61.5	57.9	56.5	54.5	51.9	46.1	39.8	63
69				54.5	53.4	54.6	51.2	51.2	48.2	47.2	43.4	37.5	69
75				43.9	47.4	48.7	46.6	45.7	43.5	42.4	40.4	35.5	75
81					42.5	43.5	43.3	41.1	40	38.3	36.7	33.6	81
87					37.5	39	39.5	37.1	36.3	35.2	33	31.7	87
93						35.3	35.7	33.9	32.9	31.9	29.7	29.6	93
99						33	32.4	31.7	30	29	26.9	26.8	99
105							29.4	29.3	28	26.4	24.4	24.3	105
111							26.8	26.7	25.7	24.2	22.2	22.1	111
117							24.6	24.3	23.4	22.1	20.2	20.1	117
123								22.2	21.3	20.2	18.4	18.4	123
129								20.4	19.4	18.4	16.8	16.7	129
135									17.7	16.7	15.2	15.3	135
141									16.1	15.1	13.7	13.9	141
147										13.7	12.3	12.5	147
153										12.5	11	11.2	153
159											9.8	10	159
165											8.8	8.9	165
171												7.9	171
177												7	177
183												6.2	183

TAB 172264

# Lifting capacities on telescopic boom

## Forces de levage à la flèche télescopique





 44 - 197 ft  
  
 360°  
 97000 lbs  
**85%**

ft	44 ft	58 ft	72 ft	86 ft	100 ft	114 ft	128 ft	142 ft	156 ft	171 ft	185 ft	197 ft	ft
10	335	308	306	306									10
12	326	305	301	298									12
14	294	284	276	270	249								14
16	267	259	252	247	238								16
18	248	241	234	229	222	196							18
21	222	216	210	205	202	191	141						21
24	199	196	191	187	182	174	139	112					24
27	177	178	173	170	160	149	131	111	91				27
30	155	157	154	147	139	131	123	107	90.5	73			30
33	133	137	136	130	123	116	110	103	87.5	73			33
36	101	122	121	116	110	103	101	96.5	84.5	71	59.7		36
39		108	109	104	99	93.5	92.5	87.5	81	69	58.5	48.5	39
45		88.5	90	86.5	82.5	81.5	77.5	73.5	70.5	64.5	55.6	46.8	45
51			75.5	73.5	70	70	66	65	61.5	59	52.3	44.6	51
57			64	63.5	61	60.5	58.4	56.8	54.2	52.3	49.2	42.2	57
63				55.1	53.5	53.1	52.2	49.7	48.2	46.6	44.3	39.8	63
69				48.9	47	47	46.5	44.5	43.2	41.5	39	37.5	69
75				41.2	41.3	42.7	41.5	40.4	38.8	36.9	34.6	34.3	75
81					36.7	39.1	37.3	36.4	34.7	32.9	30.7	30.6	81
87					33.6	35	33.7	32.8	31.3	29.5	27.4	27.3	87
93						31.5	30.7	29.8	28.2	26.6	24.5	24.5	93
99						28.5	27.9	27.1	25.6	24	22	21.9	99
105							25.2	24.6	23.3	21.7	19.7	19.7	105
111							22.8	22.2	21.2	19.7	17.8	17.7	111
117							20.7	20.1	19.1	17.9	16	15.9	117
123								18.2	17.3	16.2	14.3	14.3	123
129								16.6	15.6	14.6	12.9	12.9	129
135									14	13	11.5	11.5	135
141									12.7	11.6	10.2	10.3	141
147										10.3	8.9	9.1	147
153										9.2	7.7	8	153
159											6.7	6.9	159
165											5.8	5.9	165
171												5	171
177												4.2	177
183												3.4	183





TAB 172265

# Lifting capacities on telescopic boom

## Forces de levage à la flèche télescopique





    													
ft	44 ft	58 ft	72 ft	86 ft	100 ft	114 ft	128 ft	142 ft	156 ft	171 ft	185 ft	197 ft	ft
10	335	308	306	306									10
12	326	305	301	298									12
14	294	284	276	270	249								14
16	267	259	252	247	238								16
18	248	241	234	229	222	192							18
21	220	216	208	202	193	179	141						21
24	192	191	182	173	162	150	136	112					24
27	165	162	156	147	138	129	122	111	91				27
30	139	140	134	127	120	113	110	104	90.5	73			30
33	120	122	118	112	106	102	98	92	87.5	73			33
36	101	108	104	99.5	94	93.5	88	82.5	79.5	71	59.7		36
39		96.5	93.5	89.5	85	84.5	79.5	77	73.5	69	58.5	48.5	39
45		77.5	77.5	74	71.5	70.5	68.5	65	63	59.8	55.6	46.8	45
51			65	64.5	60.5	60	58.9	56.8	54.6	52	49	44.6	51
57			55	56.1	51.7	52.9	50.8	49.4	47.4	45.1	42.3	41	57
63				48.5	45.7	46.7	44.7	43.2	41.3	39.2	36.6	36.3	63
69				42	41.3	41.3	39.6	38	36.2	34.2	31.8	31.6	69
75				36.9	37.1	36.7	35.1	33.6	31.9	30.1	27.8	27.6	75
81					32.7	32.7	31.3	29.9	28.3	26.5	24.3	24.2	81
87					29	29.1	28	26.7	25.1	23.5	21.4	21.3	87
93						25.9	25.2	23.9	22.4	20.8	18.8	18.8	93
99						23.1	22.5	21.5	20.1	18.5	16.5	16.5	99
105							20	19.4	18	16.5	14.6	14.6	105
111							17.9	17.3	16.2	14.7	12.8	12.8	111
117							16.1	15.4	14.5	13.1	11.2	11.3	117
123								13.8	12.8	11.7	9.8	9.9	123
129								12.4	11.3	10.3	8.6	8.6	129
135									10	9	7.4	7.5	135
141									8.8	7.8	6.3	6.4	141
147										6.7	5.2	5.4	147
153										5.7	4.2	4.4	153
159											3.3	3.5	159

TAB 172267





    													
ft	44 ft	58 ft	72 ft	86 ft	100 ft	114 ft	128 ft	142 ft	156 ft	171 ft	185 ft	197 ft	ft
10	335	308	306	306									10
12	326	305	301	298									12
14	294	284	276	270	249								14
16	267	259	252	243	228								16
18	244	236	224	213	197	157							18
21	207	197	183	172	159	146	125						21
24	169	159	152	142	132	125	119	98.5					24
27	139	134	127	120	113	110	102	96	82.5				27
30	118	114	109	104	99	96	90	87	81.5	69.5			30
33	101	99	95.5	91	87	84.5	82	77.5	73.5	69.5			33
36	86	87	84.5	83.5	77	75.5	73.5	70	67	64	59.6		36
39		77.5	76	75	69	70	66.5	64	61	57.6	53.8	48.5	39
45		62	62.5	61.5	59.4	58	55.4	53	50.4	47.6	44.3	43.1	45
51			51.9	51.5	50.2	48.6	46.6	44.5	42.2	39.8	36.9	36.4	51
57			43.1	43.8	42.6	41.4	39.6	37.8	35.8	33.7	31	30.7	57
63				37.5	36.7	35.7	34.1	32.5	30.7	28.7	26.3	26.1	63
69				32.2	31.9	31	29.6	28.1	26.5	24.6	22.4	22.3	69
75				27.9	27.9	27.2	25.8	24.5	22.9	21.2	19.1	19	75
81					24.2	24	22.7	21.4	20	18.3	16.3	16.3	81
87					21.1	21.2	20	18.8	17.4	15.9	13.9	13.9	87
93						18.5	17.7	16.6	15.2	13.7	11.8	11.8	93
99						16.2	15.6	14.6	13.3	11.8	9.9	10	99
105							13.6	12.9	11.6	10.2	8.3	8.4	105
111							11.9	11.3	10.1	8.7	6.9	7	111
117							10.4	9.8	8.8	7.4	5.6	5.7	117
123								8.4	7.5	6.2	4.5	4.6	123
129								7.3	6.2	5.2	3.5	3.5	129
135									5.2	4.1			135
141									4.2	3.1			141

TAB 172269

# Lifting capacities on telescopic boom Forces de levage à la flèche télescopique

    													
ft	44 ft	58 ft	72 ft	86 ft	100 ft	114 ft	128 ft	142 ft	156 ft	171 ft	185 ft	197 ft	ft
10	329	297	297	278									10
12	297	292	291	267									12
14	269	269	257	225	192								14
16	242	235	211	192	173								16
18	211	198	180	165	149	122							18
21	166	154	144	132	122	114	94.5						21
24	132	126	118	110	103	98	91	76.5					24
27	107	105	99.5	93.5	87.5	85	80.5	74.5	63.5				27
30	86	89	85.5	83.5	76	75	70	66.5	62.5	51.5			30
33	71.5	76	74.5	72.5	69	66	62	58.5	55	51.2			33
36	60	64.5	65	63.5	61	58.4	55.3	52	48.9	45.5	41.6		36
39		55.3	57.5	56.6	54.5	52.3	49.5	46.7	43.9	40.8	37.3	36	39
45		42.2	44.5	45.9	44.4	42.7	40.5	38.2	35.8	33.3	30.3	29.7	45
51			35.3	37	36.7	35.4	33.6	31.7	29.6	27.4	24.7	24.3	51
57			28.6	30.2	30.5	29.8	28.2	26.5	24.7	22.7	20.2	20	57
63				25.1	25.4	25.3	23.9	22.4	20.8	18.9	16.6	16.5	63
69				21.1	21.3	21.5	20.4	19	17.5	15.8	13.6	13.6	69
75				17.9	18.1	18.2	17.5	16.2	14.8	13.1	11.1	11.1	75
81					15.3	15.5	14.9	13.8	12.5	10.9	8.9	8.9	81
87					13	13.1	12.6	11.8	10.5	9	7	7.1	87
93						11.1	10.6	10	8.7	7.3	5.4	5.5	93
99						9.5	8.9	8.4	7.2	5.8			99
105							7.4	6.9	5.9				105
111							6.2	5.7	4.7				111
117							5.1	4.5	3.7				117
123								3.6					123
129								2.8					129

TAB 172361

    													
ft	44 ft	58 ft	72 ft	86 ft	100 ft	114 ft	128 ft	142 ft	156 ft	171 ft	185 ft	197 ft	ft
10	327	297	295	231									10
12	294	283	254	219									12
14	255	227	199	176	142								14
16	201	180	161	144	129								16
18	163	149	135	124	111	92.5							18
21	120	113	106	100	90	85.5	68.5						21
24	92.5	88.5	84.5	80.5	75.5	70	65	52.7					24
27	73	71.5	69	66.5	63	59	54.9	50.8	41.3				27
30	58.6	58.8	57.6	56.2	53.5	50.5	47.1	43.7	40.4	32.3			30
33	46.6	49.4	49	48.2	46.1	43.7	40.9	38	35.1	32			33
36	37.9	42.2	42.1	41.8	40.2	38.2	35.8	33.3	30.8	27.9	24.6		36
39		35.8	36.7	36.7	35.3	33.8	31.6	29.4	27.1	24.5	21.5	20.7	39
45		26.3	28.5	28.9	27.9	26.8	25	23.2	21.3	19.1	16.4	16.1	45
51			22	23.1	22.4	21.5	20	18.5	16.7	14.8	12.4	12.3	51
57			16.9	18.6	18.1	17.4	16.1	14.8	13.2	11.4	9.2	9.2	57
63				14.8	14.8	14.2	13	11.8	10.3	8.7	6.6	6.6	63
69				11.7	11.9	11.6	10.5	9.3	8	6.4			69
75				9.3	9.5	9.4	8.4	7.3					75
81					7.4	7.6	6.6						81
87					5.8	5.9							87

TAB 172362

# Lifting heights Hauteurs de levage

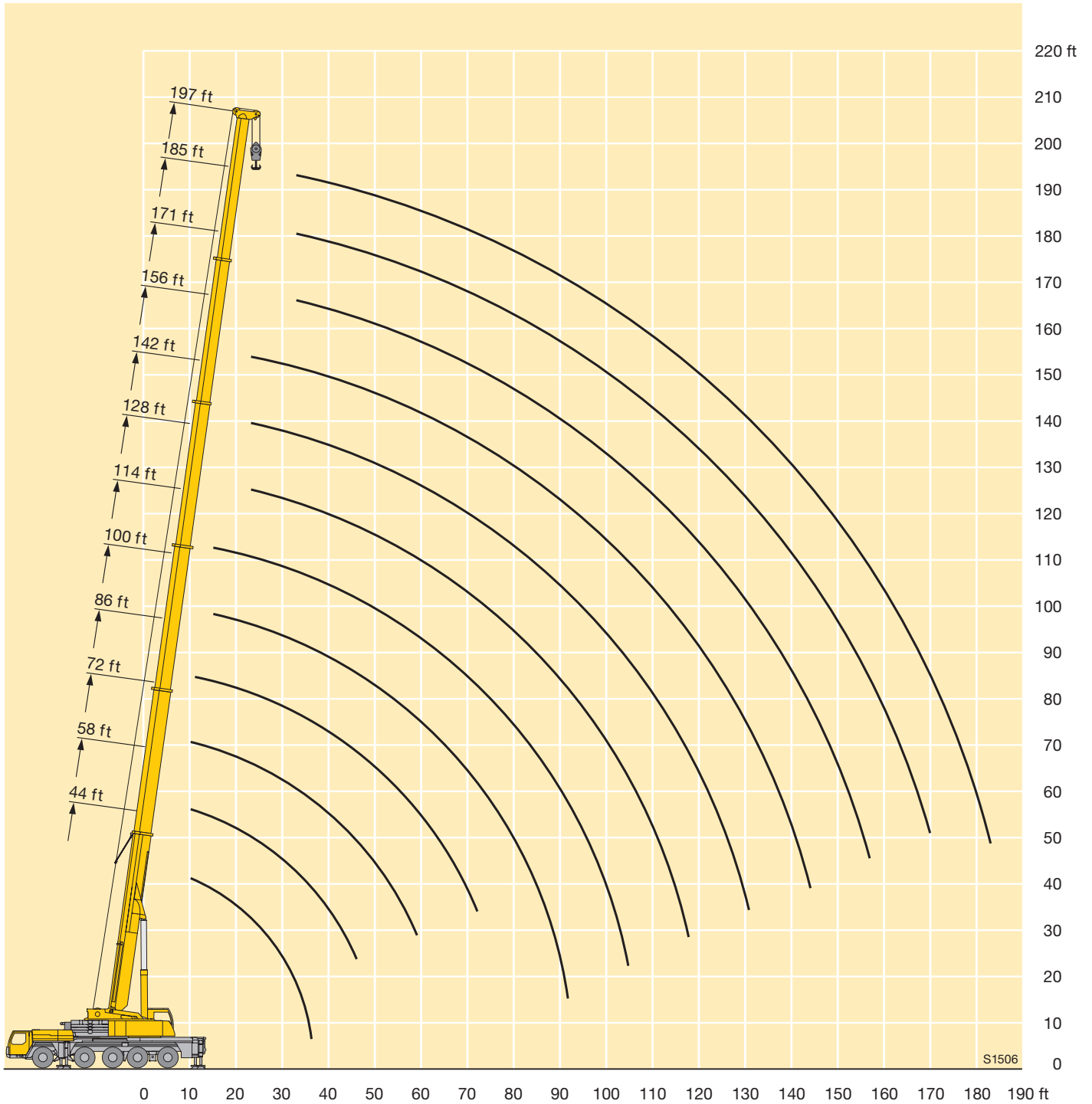

# Lifting capacities on the folding jib

## Forces de levage à la fléchette pliante



ft	44 ft			58 ft			72 ft			86 ft			100 ft			114 ft			ft
	40 ft			40 ft			40 ft			40 ft			40 ft			40 ft			
	0°	22,5°	45°	0°	22,5°	45°	0°	22,5°	45°	0°	22,5°	45°	0°	22,5°	45°	0°	22,5°	45°	
10	46.3			46.3															10
12	46.3			46.3			46.3												12
14	46.3			46.3			46.3												14
16	46.3			46.3			46.3			46.3									16
18	46.3			46.3			46.3			46.3			46.3						18
21	46.3	41.4		46.3	42.4		46.3			46.3			46.3			46.3			21
24	46.3	38.7		46.3	41.4		46.3	40.3		46.3			46.3			46.3			24
27	46.3	36		46.3	38.7		46.3	39.7		46.3	39		46.3			46.3			27
30	46.3	34.1	25.7	46.3	36.3		46.3	37.6		46.3	38.8		46.3	37.6		46.3			30
33	46.3	32.7	25.7	46.3	34.6	25.7	46.3	35.8		46.3	37		46.3	37.5		46.3			33
36	45.9	31.5	25.7	46.3	33	25.7	46.3	34.2	25.7	46.3	35.2		46.3	35.9		46.3	36.6		36
39	42	29.8	25.7	46.3	32.5	25.7	46.3	32.9	25.7	46.3	34.1	25.7	46.3	34.8		46.3	35.3		39
45	36.3	27.1	24.6	43.1	29.7	25.4	45.6	31.1	25.7	46.3	32.2	25.7	44.6	32.6	25.7	45	33.1	25.7	45
51	31.7	24.9	23.4	38.4	27.4	24.3	41.5	28.9	24.9	44.2	30.2	25.3	40.9	30.8	25.5	42	31.2	25.7	51
57	28	23.1	22.6	33.9	25.5	23.4	37.5	27	24	40.8	28.3	24.6	37.3	29.2	24.8	38.8	29.6	25.2	57
63	25.1	21.7	22.2	30.3	23.8	22.7	34.1	25.4	23.3	37.4	26.7	23.8	34.2	27.6	24.1	35.8	28.4	24.5	63
69	22.6	20.8		27.4	22.4	22.3	31.1	24	22.7	34.4	25.3	23.2	31.5	26.3	23.5	33.2	27.1	23.9	69
75				24.9	21.4	22.1	28.6	22.9	22.3	31.8	24.1	22.7	29.1	25.1	23	31	25.9	23.4	75
81				22.8	20.7		26.3	21.9	22.1	29.4	23.1	22.3	27.1	24	22.6	28.9	24.9	23	81
87							24.3	21.1	22.1	27.4	22.2	22.1	25.2	23.1	22.2	27.1	24	22.6	87
93							22.7	20.6		25.6	21.5	22.1	23.5	22.3	21.8	25.5	23.1	22.3	93
99										24	20.9	22.1	22	21.4	21.4	23.9	22.3	21.8	99
105										22.6	20.5		20.6	20.3	20.4	22.6	21.6	21.3	105
111										21.3	20.2		19.4	19.2	19.4	21.5	20.7	20.6	111
117										20.4			18.4	18.2	18.5	20.3	19.8	19.9	117
123													17.3	17.3		19.3	18.9	19.1	123
129													16.5			18.4	18.2	18.4	129
135																17.5	17.4		135
141																16.8			141

TAB 172270 / 172277 / 172284



ft	128 ft			142 ft			156 ft			171 ft			185 ft			197 ft			ft
	40 ft			40 ft			40 ft			40 ft			40 ft			40 ft			
	0°	22,5°	45°	0°	22,5°	45°	0°	22,5°	45°	0°	22,5°	45°	0°	22,5°	45°	0°	22,5°	45°	
24	46.3			46.3															24
27	46.3			46.3															27
30	46.3			46.3			45.3			39									30
33	46.3			46.3			45.1			39									33
36	46.3			46.3			44.6			38.8									36
39	45.7	35.2		46.3			44.2			38.8			33						39
45	43.1	33.3		46.3	35.2		43.5	35.7		38.4			32.8			28.6			45
51	40.3	31.5	25.7	45.9	33.7	25.7	42.7	34		38	33.2		32.6			28.4			51
57	37.5	30	25.3	44.7	32.1	25.7	41.8	32.1	25.5	37.3	32.1		32.2	29.6		28			57
63	34.8	28.8	24.7	42.8	30.8	25.4	40.8	30.7	25.3	36.3	30.7	25.3	31.7	29.3		27.7	26		63
69	32.1	27.6	24.1	40.7	29.5	24.8	39.4	29.6	24.9	35.2	29.6	25	30.9	28.5	24.5	27.1	25.6	23.8	69
75	29.9	26.5	23.6	38.6	28.3	24.3	37.7	28.7	24.4	33.9	28.6	24.5	29.7	27.6	24.3	26	24.7	23.4	75
81	27.9	25.4	23.2	36.5	27.2	23.8	36	27.7	24.1	32.3	27.6	24.1	28.4	26.8	23.9	24.9	23.7	22.5	81
87	26	24.4	22.8	34.3	26.1	23.4	34.3	26.7	23.7	30.6	26.6	23.7	27.1	25.9	23.7	23.8	22.9	21.7	87
93	24.3	23.4	22.3	32.2	25.3	23.1	32.6	25.8	23.4	29	25.9	23.4	25.9	24.8	23.2	22.8	22.1	21.1	93
99	23	22.3	21.8	30.2	24.4	22.8	30.9	25	23	27.5	25.1	23.2	24.7	23.9	22.7	21.7	21.2	20.3	99
105	21.6	21.2	21.1	28.6	23.7	22.6	29.2	24.3	22.8	26.2	24.3	23	23.5	22.9	22	20.7	20.4	19.6	105
111	20.2	20	20.1	27.1	23.1	22.4	27.7	23.6	22.7	24.9	23.5	22.8	22.4	22	21.2	19.6	19.5	18.9	111
117	19.2	18.9	19	25.5	22.5	22.1	26.4	23	22.5	23.6	22.7	22.1	21.4	21.1	20.5	18.7	18.6	18.2	117
123	18.1	18	18.1	24.2	22	22.1	24.8	22.5	22.3	22.5	21.9	21.5	20.4	20.2	19.7	17.8	17.8	17.5	123
129	17.1	17.1	17.3	23	21.4	22.1	22.8	22	22	21.4	21.1	20.8	19.4	19.3	19	17	17	16.8	129
135	16.2	16.2	16.4	21.8	20.8	21.6	20.9	21.4	21.7	20.4	20.3	20.1	18.6	18.4	18.3	16.1	16.2	16.2	135
141	15.4	15.4	15.6	20.5	20.1	20.7	19.1	20.1	20.6	19.2	19.4	19.3	17.8	17.6	17.6	15.3	15.5	15.5	141
147	14.6	14.7		19	19.3	19.7	17.9	18.4	18.9	17.8	18.4	18.5	17	16.9	16.9	14.7	14.7	14.8	147
153	13.9			17.5	18.1	18.3	17	17.1	17.4	16.3	17.2	17.5	16.3	16.3	16.2	14	14.1	14.2	153
159				16.2	16.7		16.1	16.2	16.4	15	15.7	16.2	15.4	15.6	15.6	13.4	13.5	13.6	159
165				14.9	15.3		15.1	15.4	15.6	14.3	14.5	14.8	14.2	14.8	14.9	12.7	12.8	13	165
171							13.9	14.4		13.6	13.8	13.9	13	13.7	14.1	12.1	12.2	12.4	171
177							12.9	13.2		13.1	13.2	13.3	11.9	12.6	12.8	11.6	11.7	11.8	177
183							11.4	11.6		12.3	12.6	12.7	10.9	11.5	11.7	10.7	11.2	11.4	183
189										11.4	11.7		10	10.5	10.7	9.8	10.4	10.6	189
195										9.6			9.2	9.6	9.7	9	9.5	9.6	195
207													7.2	7.9		7.4	7.8	7.8	207

TAB 172270 / 172277 / 172284

# Lifting capacities on the folding jib Forces de levage à la fléchette pliante



ft	44 ft			58 ft			72 ft			86 ft			100 ft			114 ft			ft
	72 ft			72 ft			72 ft			72 ft			72 ft			72 ft			
	0°	22,5°	45°	0°	22,5°	45°	0°	22,5°	45°	0°	22,5°	45°	0°	22,5°	45°	0°	22,5°	45°	
12	23.4																		12
14	23.4			23.4															14
16	23.4			23.4			23.3												16
18	23.4			23.4			23.3			22.6									18
21	23.4			23.4			23.2			22.5			21.6			21.1			21
24	23.4			23.4			23			22.3			21.6			21			24
27	23.3			23.4			23			22.3			21.5			20.8			27
30	23.2			23.4			23			22			21.3			20.6			30
33	22.7			23.3			22.7			21.8			21.3			20.6			33
36	22.1			23			22.4			21.8			21.3			20.4			36
39	21.6	18.7		22.5			22.1			21.7			21.1			20.4			39
45	20.5	17.6		21.5	18		21.3	17.7		21.2			20.6			20.2			45
51	19.3	16.6		20.5	17.2		20.5	17.1		20.5	17		20	16.7		19.7			51
57	18.1	15.7		19.5	16.3		19.7	16.3		19.8	16.5		19.5	16.2		19.3	16		57
63	17	15	12.9	18.4	15.6	12.9	18.8	15.7	12.9	19	15.9		18.9	15.8		18.8	15.8		63
69	16	14.2	12.5	17.5	15	12.7	17.9	15.2	12.7	18.3	15.3	12.6	18.3	15.3	12.6	18.2	15.3		69
75	15	13.5	12.1	16.5	14.3	12.4	17.1	14.5	12.4	17.5	14.8	12.5	17.6	14.8	12.4	17.7	14.8	12.3	75
81	14	12.9	11.8	15.6	13.7	12.1	16.3	14	12.1	16.8	14.2	12.2	17	14.3	12.2	17.2	14.4	12.2	81
87	13.1	12.4	11.6	14.7	13.1	11.8	15.5	13.5	11.9	16.1	13.7	11.9	16.3	13.9	11.9	16.6	14	11.9	87
93	12.1	12	11.5	13.9	12.7	11.6	14.8	13	11.7	15.5	13.3	11.8	15.7	13.4	11.8	16	13.6	11.8	93
99	11.2	11.7		13	12.3	11.5	14	12.6	11.5	14.8	12.9	11.6	15.2	13.1	11.6	15.4	13.2	11.6	99
105				12.2	11.9	11.5	13.3	12.2	11.4	14.2	12.5	11.4	14.6	12.7	11.4	15	12.9	11.5	105
111				11.3	11.7	11.5	12.6	12	11.4	13.6	12.2	11.4	14.1	12.4	11.4	14.5	12.6	11.3	111
117				10.5	11.6		11.9	11.7	11.4	13	12	11.4	13.6	12.1	11.3	14	12.3	11.3	117
123							11.2	11.5	11.4	12.3	11.7	11.4	13	11.9	11.3	13.5	12	11.2	123
129							10.6	11.4		11.8	11.6	11.4	12.5	11.7	11.3	13.1	11.8	11.2	129
135										11.2	11.5	11.4	12	11.5	11.3	12.6	11.6	11.2	135
141										10.6	11.4		11.5	11.4	11.3	12.2	11.5	11.2	141
147													11	11.3	11.3	11.8	11.4	11.2	147
153													10.6	11.2		11.4	11.3	11.2	153
159													10.2			11	11.2	11.2	159
165																10.5	11.2		165
171																10.2			171
177																10			177

TAB 172270 / 172277 / 172284

# Lifting capacities on the folding jib Forces de levage à la fléchette pliante



ft	128 ft			142 ft			156 ft			171 ft			185 ft			197 ft			ft
	72 ft			72 ft			72 ft			72 ft			72 ft			72 ft			
	0°	22,5°	45°	0°	22,5°	45°	0°	22,5°	45°	0°	22,5°	45°	0°	22,5°	45°	0°	22,5°	45°	
24	19.9																		24
27	19.9			20.6															27
30	19.9			20.6			19.6												30
33	19.6			20.6			19.6												33
36	19.6			20.6			19.6			18.2									36
39	19.6			20.6			19.6			18.2			16.3						39
45	19.5			20.3			19.5			18			16.3			14.8			45
51	19.1			19.9			19.2			18			16.3			14.8			51
57	18.7	15.8		19.5	16.3		18.9			17.8			16.3			14.6			57
63	18.3	15.5		19.1	16		18.5	15.5		17.5			16.1			14.6			63
69	17.9	15		18.6	15.6		18.1	15.3		17.1	14.6		15.9	13.8		14.6			69
75	17.4	14.7	12.2	18.2	15.2	12.1	17.7	14.9		16.8	14.5		15.6	13.7		14.5	12.9		75
81	16.9	14.3	12.1	17.7	14.8	12	17.3	14.6	11.9	16.5	14.1		15.4	13.5		14.3	12.8		81
87	16.4	13.9	11.9	17.3	14.4	11.9	16.9	14.2	11.8	16.2	13.8	11.7	15.1	13.2	11.2	14.2	12.7		87
93	16	13.6	11.7	16.8	14	11.9	16.5	13.9	11.6	15.8	13.5	11.6	14.8	13	11.2	14	12.5	10.9	93
99	15.5	13.2	11.6	16.3	13.7	11.7	16.1	13.6	11.6	15.4	13.2	11.5	14.6	12.7	11.2	13.7	12.3	10.9	99
105	15	12.9	11.4	15.8	13.3	11.6	15.6	13.3	11.5	15.1	12.9	11.4	14.3	12.5	11.1	13.5	12.1	10.9	105
111	14.6	12.6	11.3	15.3	13	11.4	15.3	13	11.4	14.8	12.7	11.2	14	12.3	11.1	13.3	11.9	10.9	111
117	14.1	12.4	11.2	14.9	12.7	11.3	14.8	12.7	11.2	14.4	12.5	11.1	13.7	12.1	11	13.1	11.7	10.8	117
123	13.7	12.1	11.2	14.4	12.5	11.2	14.4	12.5	11.2	14.1	12.2	11	13.5	11.9	10.9	12.9	11.6	10.7	123
129	13.3	11.9	11.1	14	12.2	11.1	14.1	12.2	11.1	13.8	12	11	13.2	11.7	10.8	12.7	11.4	10.7	129
135	13	11.7	11.1	13.7	12	11	13.7	12	11	13.4	11.8	10.9	13	11.6	10.8	12.4	11.3	10.6	135
141	12.6	11.5	11.1	13.3	11.8	10.9	13.4	11.8	11	13.1	11.7	10.9	12.7	11.4	10.7	12.1	11.1	10.6	141
147	12.2	11.4	11.1	12.9	11.6	10.9	13	11.6	11	12.9	11.5	10.9	12.5	11.3	10.7	11.8	11	10.6	147
153	11.8	11.2	11.1	12.6	11.4	10.9	12.7	11.5	10.9	12.6	11.4	10.9	12.2	11.1	10.7	11.5	10.9	10.6	153
159	11.4	11.1	11.1	12.3	11.3	10.9	12.4	11.3	10.9	12.4	11.2	10.9	12	11	10.7	11.2	10.7	10.6	159
165	11	10.9	11.1	12	11.2	10.9	12.2	11.2	10.9	12.1	11.1	10.9	11.8	10.9	10.7	10.8	10.5	10.5	165
171	10.5	10.6	10.9	11.6	11.1	10.9	11.9	11.1	10.9	11.9	11	10.9	11.5	10.8	10.7	10.4	10.3	10.4	171
177	10	10.2	10.5	11.3	10.9	10.9	11.7	11.1	10.9	11.6	10.9	10.9	11.3	10.7	10.7	10	10.2	10.2	177
183	9.6	9.8		11	10.9	10.9	11.4	11	10.9	11.4	10.9	10.9	11.1	10.6	10.7	9.5	9.8	10	183
189	9.3			10.6	10.9	10.5	11	11	10.9	10.7	10.8	10.9	10.7	10.5	10.7	9.1	9.4	9.7	189
195				10.3	10.9		10.6	10.8	10.9	10	10.6	10.9	10.1	10.3	10.6	8.7	9	9.3	195
207							9.6	10		9.2	9.3	9.5	8.6	9.4	9.8	8	8.2	8.5	207
219										8.4	8.6		7.2	7.9	8	6.9	7.5	7.7	219
231													5.9	6.4		5.6	6.3	6.4	231
243																4.6	5.1		243

TAB 172270 / 172277 / 172284

# Lifting heights Hauteurs de levage

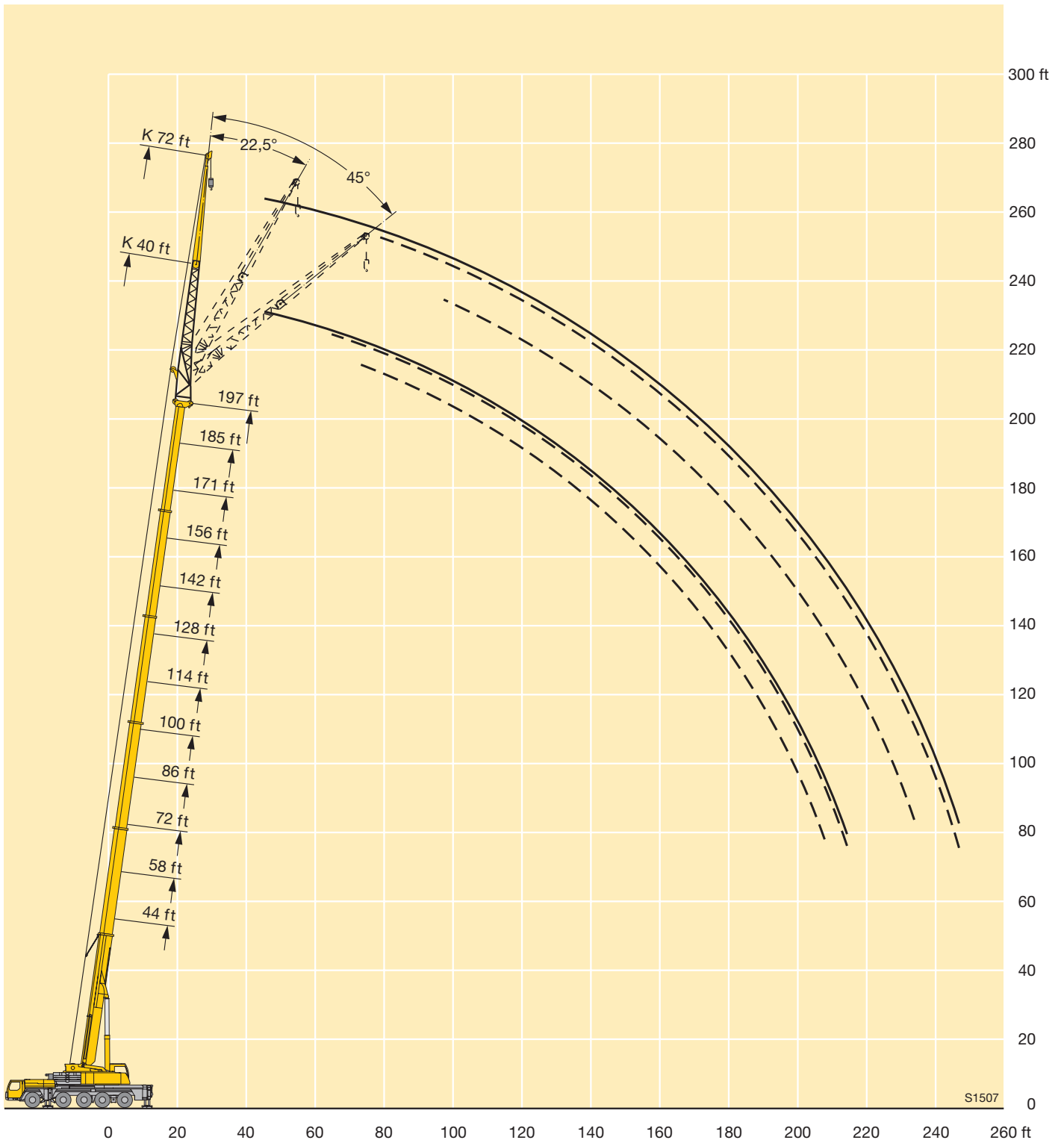

# Lifting capacities on the folding jib Forces de levage à la fléchette pliante



ft	44 ft			58 ft			72 ft			86 ft			100 ft			114 ft			ft
	95 ft			95 ft			95 ft			95 ft			95 ft			95 ft			
	0°	22,5°	45°	0°	22,5°	45°	0°	22,5°	45°	0°	22,5°	45°	0°	22,5°	45°	0°	22,5°	45°	
16	19			18.9															16
18	18.9			18.9			18												18
21	18.9			18.9			18			17.2									21
24	18.9			18.9			17.9			17.1			16.3						24
27	18.9			18.9			17.7			17			16.3			15.5			27
30	18.7			18.9			17.7			16.9			16.2			15.5			30
33	18.5			18.8			17.7			16.7			16			15.5			33
36	18.2			18.6			17.7			16.7			16			15.3			36
39	17.8			18.4			17.6			16.5			15.8			15.3			39
45	16.9			17.6			17.1			16.5			15.8			15.1			45
51	15.9	13		16.8			16.5			16.3			15.6			14.9			51
57	14.9	12.4		15.9	12.6		15.7	12.5		15.7			15.2			14.8			57
63	13.8	11.6		15	12.1		15	12		15	11.7		14.7	11.4		14.5			63
69	12.9	10.9		14	11.4		14.2	11.4		14.4	11.4		14.2	11.2		14.1	11		69
75	12	10.2		13.1	10.7		13.4	10.8		13.7	10.9		13.6	10.8		13.6	10.8		75
81	11.1	9.6	8.1	12.3	10.1	8.1	12.7	10.2	8	13	10.3	8.1	13	10.3		13	10.3		81
87	10.3	9	7.8	11.5	9.6	8	11.9	9.8	7.9	12.4	9.9	8	12.4	9.9	7.7	12.5	9.9	7.7	87
93	9.5	8.5	7.4	10.8	9.1	7.7	11.3	9.3	7.7	11.7	9.5	7.7	11.9	9.5	7.7	12	9.6	7.7	93
99	8.8	8.1	7.2	10	8.6	7.4	10.7	8.9	7.4	11.2	9.1	7.5	11.3	9.1	7.5	11.6	9.2	7.5	99
105	8.1	7.7	6.9	9.4	8.2	7.2	10	8.5	7.2	10.6	8.7	7.3	10.8	8.8	7.3	11.1	8.9	7.3	105
111	7.5	7.4	6.8	8.6	7.9	7	9.5	8.1	7	10.1	8.3	7.1	10.4	8.5	7.1	10.6	8.6	7.1	111
117	6.9	7.1	6.7	8	7.6	6.8	8.9	7.8	6.9	9.6	8	6.9	9.9	8.2	6.9	10.2	8.3	7	117
123	6.4	6.8		7.5	7.3	6.7	8.3	7.5	6.8	9.1	7.8	6.8	9.5	7.9	6.8	9.8	8.1	6.8	123
129	6			7	7	6.7	7.8	7.3	6.7	8.6	7.5	6.7	9	7.6	6.7	9.4	7.8	6.7	129
135				6.5	6.8		7.3	7.1	6.7	8.1	7.3	6.6	8.6	7.4	6.6	9	7.6	6.6	135
141				6.1			6.9	6.9	6.6	7.6	7.1	6.6	8.2	7.2	6.6	8.6	7.4	6.6	141
147							6.5	6.8		7.2	6.9	6.6	7.8	7	6.6	8.3	7.2	6.5	147
153							6.1			6.8	6.7	6.6	7.4	6.9	6.6	7.9	7	6.5	153
159										6.5	6.7		7	6.7	6.6	7.6	6.8	6.5	159
165										6.1			6.7	6.6	6.6	7.2	6.7	6.5	165
171													6.4	6.6		7	6.6	6.5	171
177													6.1	6.6		6.6	6.5	6.5	177
183													5.9			6.4	6.5	6.5	183
189																6.1	6.5		189
195																5.9	6.4		195

TAB 172270 / 172277 / 172284

# Lifting capacities on the folding jib

## Forces de levage à la fléchette pliante



ft	128 ft			142 ft			156 ft			171 ft			185 ft			197 ft			ft
	95 ft			95 ft			95 ft			95 ft			95 ft			95 ft			
	0°	22,5°	45°	0°	22,5°	45°	0°	22,5°	45°	0°	22,5°	45°	0°	22,5°	45°	0°	22,5°	45°	
30	14.6			15.5															30
33	14.6			15.5															33
36	14.6			15.5			14.6												36
39	14.3			15.5			14.6			13.3									39
45	14.3			15.5			14.6			13.3			11.9						45
51	14.3			15.3			14.6			13.3			11.9			10.7			51
57	14.3			15			14.4			13.3			11.9			10.7			57
63	14			14.7			14.2			13.2			11.9			10.7			63
69	13.7	10.7		14.4	11.2		13.9			13			11.8			10.7			69
75	13.3	10.5		14	11		13.6	10.4		12.7			11.6			10.7			75
81	12.8	10.2		13.6	10.6		13.2	10.4		12.4	9.7		11.5	9.2		10.6			81
87	12.4	9.8		13.1	10.2		12.8	10.1		12.1	9.7		11.2	9.2		10.5	8.5		87
93	11.9	9.5	7.3	12.7	9.9	7.3	12.5	9.8		11.8	9.5		11	9		10.2	8.5		93
99	11.5	9.2	7.3	12.2	9.6	7.3	12	9.5		11.5	9.2	7	10.7	8.8		10.1	8.2		99
105	11.1	8.9	7.2	11.8	9.2	7.3	11.6	9.2	7	11.2	8.9	7	10.5	8.6		9.8	8		105
111	10.7	8.6	7.1	11.4	9	7.1	11.3	8.9	7.1	10.9	8.7	6.8	10.2	8.3	6.6	9.6	8		111
117	10.3	8.3	6.9	11	8.7	7	10.9	8.6	7	10.5	8.4	6.8	10	8.1	6.6	9.4	7.9	6.3	117
123	9.9	8.1	6.8	10.6	8.4	6.9	10.6	8.4	6.9	10.2	8.2	6.8	9.7	7.9	6.6	9.2	7.7	6.3	123
129	9.5	7.8	6.7	10.2	8.2	6.8	10.2	8.2	6.8	9.9	8	6.7	9.5	7.8	6.5	9	7.5	6.3	129
135	9.2	7.6	6.6	9.8	7.9	6.7	9.9	7.9	6.7	9.6	7.8	6.6	9.2	7.6	6.5	8.8	7.4	6.3	135
141	8.9	7.4	6.5	9.5	7.7	6.6	9.5	7.7	6.6	9.4	7.6	6.5	9	7.4	6.4	8.6	7.2	6.3	141
147	8.5	7.2	6.5	9.1	7.5	6.5	9.2	7.6	6.5	9.1	7.5	6.4	8.8	7.3	6.3	8.4	7.1	6.2	147
153	8.2	7.1	6.4	8.8	7.3	6.5	8.9	7.4	6.4	8.8	7.3	6.4	8.5	7.1	6.3	8.2	7	6.1	153
159	7.9	6.9	6.4	8.5	7.2	6.4	8.7	7.2	6.4	8.5	7.2	6.3	8.3	7	6.2	8	6.8	6.1	159
165	7.6	6.8	6.4	8.2	7	6.4	8.4	7	6.3	8.3	7	6.3	8.1	6.9	6.1	7.9	6.7	6.1	165
171	7.3	6.7	6.4	7.9	6.9	6.4	8.1	6.9	6.3	8.1	6.8	6.2	7.9	6.7	6.1	7.7	6.6	6	171
177	7	6.6	6.4	7.7	6.7	6.4	7.9	6.8	6.3	7.9	6.7	6.1	7.7	6.6	6.1	7.5	6.5	6	177
183	6.8	6.5	6.4	7.4	6.6	6.3	7.6	6.6	6.3	7.6	6.6	6.1	7.5	6.5	6.1	7.3	6.4	6	183
189	6.6	6.3	6.4	7.1	6.5	6.3	7.4	6.5	6.3	7.4	6.5	6.1	7.3	6.4	6.1	7.1	6.3	6	189
195	6.3	6.3	6.4	6.9	6.4	6.3	7.2	6.5	6.3	7.2	6.4	6.1	7.2	6.4	6.1	7	6.2	6	195
207	5.9			6.4	6.3	6.3	6.7	6.3	6.3	6.9	6.2	6.1	6.9	6.2	6.1	6.6	6.1	6	207
219				6	6.3		6.3	6.2		6.5	6.1	6.1	6.6	6.1	6.1	6.2	6	6	219
231							5.9			6.1	6.1	6.1	6	6.1	6.1	5.6	5.8	6	231
243										5.8			5.1	5.7	5.8	4.7	5.3	5.6	243
255													4	4.6		3.7	4.5	4.5	255
267																2.8	3.3		267

TAB 172270 / 172277 / 172284

# Lifting heights Hauteurs de levage

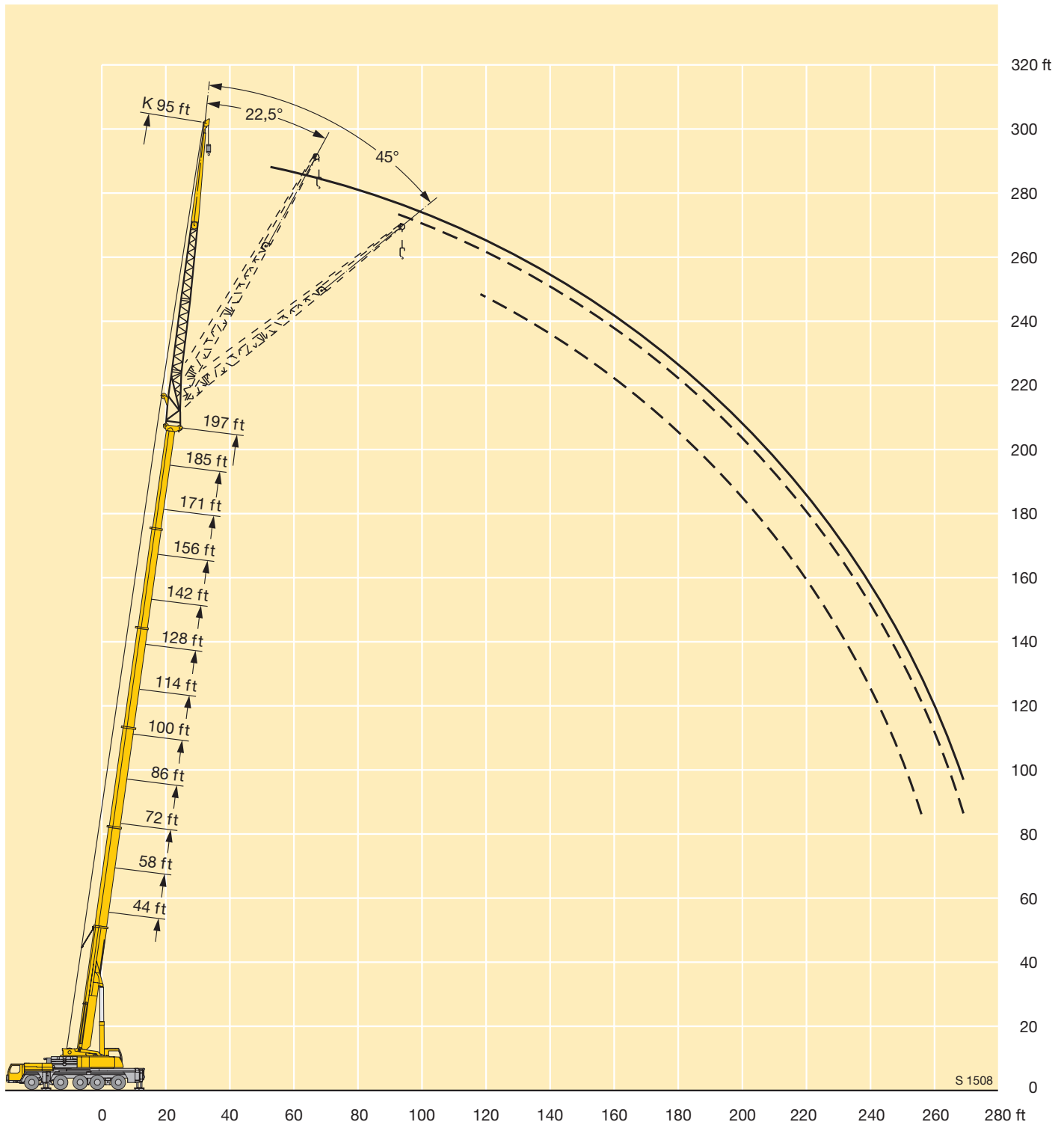

# Lifting capacities on the folding jib Forces de levage à la fléchette pliante



ft	44 ft			58 ft			72 ft			86 ft			100 ft			114 ft			ft
	118 ft			118 ft			118 ft			118 ft			118 ft			118 ft			
	0°	22,5°	45°	0°	22,5°	45°	0°	22,5°	45°	0°	22,5°	45°	0°	22,5°	45°	0°	22,5°	45°	
21	13.9			13.8															21
24	13.9			13.8			12.9			12.4									24
27	13.8			13.8			12.9			12.4			11.6						27
30	13.6			13.8			12.8			12.4			11.6			11.2			30
33	13.6			13.6			12.6			12.4			11.6			11.2			33
36	13.5			13.6			12.6			12.1			11.6			11.2			36
39	13.3			13.6			12.6			12.1			11.4			11.2			39
45	12.7			13.2			12.6			12.1			11.4			11			45
51	12			12.6			12.2			11.9			11.2			10.9			51
57	11.3			11.9			11.6			11.5			11			10.8			57
63	10.5	8.4		11.2	8.5		11.1			11			10.7			10.5			63
69	9.8	8.1		10.6	8.3		10.5	8		10.5			10.3			10.2			69
75	9.1	7.5		9.9	7.8		9.9	7.8		10	7.5		9.9	7.4		9.8			75
81	8.5	7		9.2	7.3		9.4	7.3		9.5	7.3		9.4	7.2		9.4	6.8		81
87	7.9	6.6		8.6	6.9		8.8	6.9		9	6.9		9	6.9		9	6.7		87
93	7.3	6.2	4.8	8.1	6.5	4.9	8.3	6.5		8.6	6.6		8.6	6.5		8.6	6.5		93
99	6.8	5.8	4.8	7.6	6.1	4.9	7.8	6.2	4.6	8.1	6.3	4.6	8.2	6.3		8.2	6.3		99
105	6.3	5.4	4.7	7.1	5.8	4.8	7.4	5.9	4.6	7.6	6	4.6	7.8	6		7.9	6		105
111	5.8	5.1	4.5	6.6	5.5	4.6	6.9	5.6	4.6	7.2	5.7	4.6	7.4	5.7	4.6	7.5	5.7	4.6	111
117	5.4	4.9	4.3	6.1	5.2	4.4	6.5	5.3	4.5	6.9	5.4	4.5	7	5.5	4.5	7.2	5.5	4.5	117
123	5	4.6	4.2	5.7	4.9	4.3	6.1	5.1	4.3	6.5	5.2	4.4	6.7	5.2	4.4	6.8	5.3	4.4	123
129	4.6	4.4	4.1	5.3	4.7	4.2	5.8	4.8	4.2	6.1	5	4.3	6.4	5	4.3	6.5	5.1	4.3	129
135	4.3	4.2	4	4.9	4.5	4.1	5.4	4.7	4.1	5.8	4.8	4.2	6	4.9	4.2	6.3	4.9	4.2	135
141	4	4.1	4	4.6	4.4	4	5.1	4.5	4.1	5.5	4.6	4.1	5.7	4.7	4.1	6	4.8	4.1	141
147	3.8	4.1		4.3	4.2	4	4.7	4.3	4	5.2	4.5	4	5.5	4.5	4	5.7	4.6	4	147
153				4	4.1		4.5	4.2	4	4.9	4.3	3.9	5.2	4.4	3.9	5.4	4.5	3.9	153
159				3.8	4		4.2	4.1	3.9	4.6	4.2	3.9	4.9	4.3	3.9	5.2	4.4	3.9	159
165							4	4		4.4	4.1	3.9	4.7	4.2	3.9	5	4.3	3.9	165
171							3.8	4		4.2	4	3.9	4.4	4.1	3.9	4.8	4.1	3.8	171
177							3.6	4		4	4	3.9	4.3	4	3.9	4.6	4.1	3.8	177
183										3.8	3.9		4.1	3.9	3.9	4.4	4	3.8	183
189										3.7	3.9		3.9	3.9	3.9	4.2	3.9	3.8	189
195													3.8	3.9		4	3.9	3.8	195
207													3.6			3.7	3.8		207
219																3.6			219

TAB 172270 / 172277 / 172284

# Lifting capacities on the folding jib

## Forces de levage à la fléchette pliante



ft	128 ft			142 ft			156 ft			171 ft			185 ft			197 ft			ft
	118 ft			118 ft			118 ft			118 ft			118 ft			118 ft			
	0°	22,5°	45°	0°	22,5°	45°	0°	22,5°	45°	0°	22,5°	45°	0°	22,5°	45°	0°	22,5°	45°	
36	10.4			11.2															36
39	10.4			11.2															39
45	10.2			11			10.4			9.5									45
51	10			10.9			10.2			9.5			8.3						51
57	9.9			10.9			10.2			9.5			8.3			7.3			57
63	9.9			10.7			10.2			9.4			8.3			7.3			63
69	9.8			10.4			10			9.3			8.3			7.3			69
75	9.5			10.1			9.7			9.1			8.2			7.3			75
81	9.2	6.9		9.7	7		9.4			8.8			8.1			7.3			81
87	8.9	6.8		9.4	7		9.1	6.6		8.6			7.9			7.2			87
93	8.5	6.5		9.1	6.7		8.9	6.5		8.3	6.1		7.7			7.1			93
99	8.2	6.2		8.7	6.5		8.5	6.4		8.1	6		7.5	5.6		7	5.3		99
105	7.8	6		8.4	6.2		8.2	6.1		7.8	5.8		7.3	5.6		6.8	5.3		105
111	7.5	5.7		8	6		7.9	5.9		7.6	5.6		7.1	5.4		6.6	5.1		111
117	7.2	5.5	4.4	7.7	5.8	4.4	7.6	5.7		7.3	5.4		6.9	5.1		6.4	4.9		117
123	6.9	5.3	4.3	7.4	5.6	4.4	7.4	5.5	4.1	7.1	5.3	4.1	6.7	5.1		6.3	4.9		123
129	6.6	5.1	4.2	7.1	5.4	4.3	7.1	5.3	4.1	6.8	5.2	4.1	6.5	5	3.9	6.1	4.8		129
135	6.3	5	4.1	6.8	5.2	4.2	6.8	5.2	4.1	6.6	5	4.1	6.2	4.9	3.9	5.9	4.7	3.6	135
141	6.1	4.8	4.1	6.5	5	4.1	6.6	5	4.1	6.4	4.9	4.1	6	4.7	3.9	5.8	4.6	3.6	141
147	5.8	4.6	4	6.2	4.8	4.1	6.3	4.8	4	6.2	4.8	4	5.9	4.6	3.9	5.6	4.5	3.6	147
153	5.6	4.5	3.9	6	4.7	4	6	4.7	4	5.9	4.6	3.9	5.7	4.5	3.8	5.4	4.4	3.6	153
159	5.3	4.4	3.9	5.8	4.6	3.9	5.8	4.6	3.9	5.7	4.5	3.9	5.5	4.4	3.8	5.3	4.3	3.6	159
165	5.1	4.3	3.8	5.5	4.4	3.9	5.6	4.5	3.9	5.5	4.4	3.8	5.3	4.3	3.7	5.1	4.2	3.6	165
171	4.9	4.2	3.8	5.3	4.3	3.8	5.4	4.4	3.8	5.3	4.3	3.8	5.2	4.2	3.7	5	4.1	3.6	171
177	4.8	4.1	3.8	5.1	4.3	3.8	5.2	4.3	3.8	5.2	4.2	3.7	5	4.1	3.7	4.9	4.1	3.6	177
183	4.6	4	3.8	4.9	4.1	3.8	5	4.2	3.7	5	4.1	3.7	4.9	4.1	3.6	4.7	4	3.6	183
189	4.4	3.9	3.8	4.8	4.1	3.8	4.8	4.1	3.7	4.8	4.1	3.7	4.7	4	3.6	4.6	3.9	3.6	189
195	4.2	3.9	3.8	4.6	4	3.7	4.7	4	3.7	4.7	4	3.6	4.6	3.9	3.6	4.5	3.9	3.5	195
207	4	3.7	3.8	4.3	3.9	3.7	4.4	3.8	3.6	4.4	3.8	3.6	4.4	3.8	3.6	4.3	3.7	3.5	207
219	3.7	3.6		4	3.6	3.7	4.2	3.7	3.6	4.2	3.7	3.6	4.1	3.7	3.6	4.1	3.6	3.5	219
231	3.6			3.8	3.6		3.9	3.6	3.6	4	3.7	3.6	4	3.6	3.6	3.9	3.6	3.4	231
243							3.7	3.6		3.8	3.6	3.6	3.8	3.4	3.6	3.8	3.5	3.4	243
255							3.6	3.6		3.7	3.6	3.6	3.7	3.4	3.6	3.6	3.5	3.4	255
267										3.5	3.6		3.1	3.4	3.6	2.8	3.5	3.4	267
279														2.9			2.8		279

TAB 172270 / 172277 / 172284

# Lifting heights Hauteurs de levage

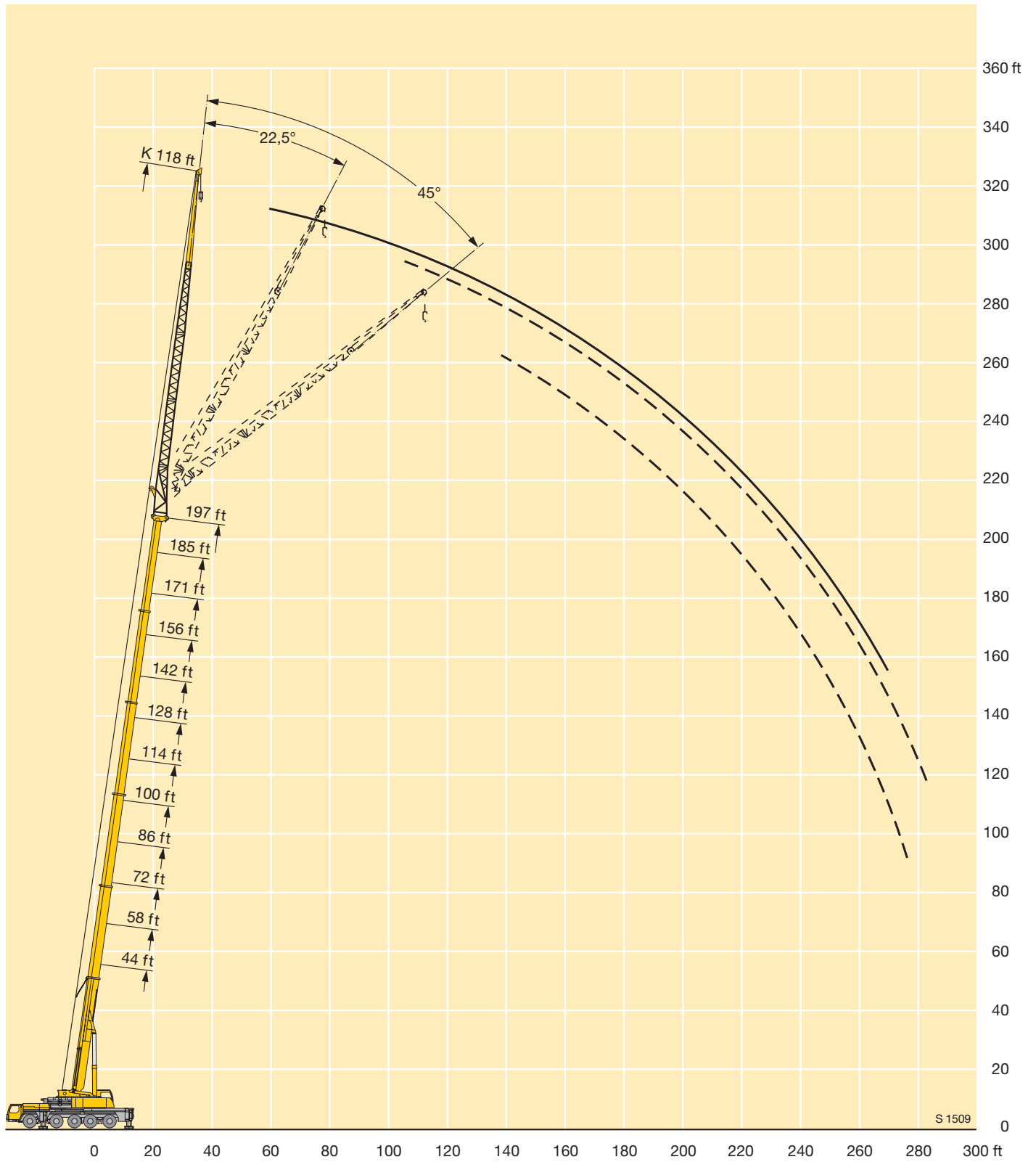

# Lifting capacities on the hydraulically variable folding jib

## Capacités de levage à la fléchette pliante à variation hydraulique



ft	44 ft			58 ft			72 ft			86 ft			100 ft			114 ft			ft
	40 ft			40 ft			40 ft			40 ft			40 ft			40 ft			
	0°	22,5°	45°	0°	22,5°	45°	0°	22,5°	45°	0°	22,5°	45°	0°	22,5°	45°	0°	22,5°	45°	
10	46.3			46.3															10
12	46.3			46.3															12
14	46.3			46.3															14
16	46.3			46.3															16
18	46.3			46.3															18
21	46.3	40.7		46.3	41.7														21
24	46.3	38.3		46.3	40.8														24
27	46.3	35.6		46.3	38.2														27
30	46.3	33.6	25.7	46.3	35.9														30
33	46.2	32.2	25.7	46.3	34.1	25.7													33
36	45.4	31.2	25.7	46.3	32.5	25.7	46.3	33.8	25.7	46.3	34.7								36
39	41.5	29.6	25.7	46.3	32.1	25.7	46.3	32.4	25.7	46.3	33.6	25.7	46.3	34.3					39
45	36	26.9	24.5	42.6	29.4	25.3	45.2	30.7	25.7	46.3	31.8	25.7	44.2	32.1	25.7	44.6	32.6	25.7	45
51	31.4	24.8	23.3	38	27.2	24.2	41	28.6	24.8	43.8	29.9	25.2	40.4	30.4	25.4	41.5	30.8	25.6	51
57	27.8	23.1	22.5	33.5	25.3	23.3	37.1	26.8	23.9	40.3	28	24.4	36.8	28.9	24.7	38.3	29.2	25	57
63	24.9	21.7	22.1	30.1	23.7	22.6	33.7	25.2	23.1	36.9	26.5	23.6	33.8	27.3	24	35.3	28	24.3	63
69	22.5	20.7		27.2	22.4	22.2	30.8	23.9	22.6	34	25.2	23.1	31	26	23.4	32.8	26.9	23.7	69
75				24.8	21.4	22.1	28.3	22.8	22.2	31.4	24	22.6	28.7	24.9	22.9	30.5	25.7	23.3	75
81				22.8	20.7		26.2	21.8	22.1	29.1	23	22.3	26.7	23.8	22.6	28.5	24.7	22.9	81
87							24.2	21.1	22.1	27.2	22.1	22.1	24.8	22.9	22.2	26.7	23.8	22.5	87
93							22.6	20.5		25.4	21.4	22.1	23.1	22	21.6	25.1	22.9	22.2	93
99										23.8	20.8	22.1	21.7	21	21.1	23.5	22.1	21.7	99
105										22.5	20.5		20.2	19.9	20.1	22.2	21.3	21	105
111										21.3	20.2		19	18.8	19.1	21	20.4	20.3	111
117										20.4			18	17.8	18.1	19.9	19.4	19.5	117
123													16.9	16.9		18.9	18.6	18.7	123
129													16.1			18	17.8	18	129
135																17.1	17		135
141																16.4			141

TAB 172312 / 172319 / 172326



ft	128 ft			142 ft			156 ft			171 ft			185 ft			197 ft			ft
	40 ft			40 ft			40 ft			40 ft			40 ft			40 ft			
	0°	22,5°	45°	0°	22,5°	45°	0°	22,5°	45°	0°	22,5°	45°	0°	22,5°	45°	0°	22,5°	45°	
24	46.3			46.3															24
27	46.3			46.3															27
30	46.3			46.3			45.1												30
33	46.3			46.3			44.8												33
36	45.9			46.3			44.4												36
39	45	34.7		46.3			44												39
45	42.6	32.8		46.1	34.7		43.5	35.2											45
51	39.8	31	25.7	45.7	33.2	25.7	42.6	33.5											51
57	37	29.7	25.1	44.4	31.6	25.7	41.6	31.7	25.5	36.9	31.6								57
63	34.3	28.5	24.5	42.5	30.4	25.3	40.4	30.2	25.2	35.9	30.3	25	31.1	28.8					63
69	31.7	27.3	23.9	40.3	29.2	24.7	39	29.2	24.6	34.8	29.3	24.8	30.2	28	24.3	26.7	25.1	23.5	69
75	29.4	26.3	23.5	38.2	28	24.2	37.3	28.4	24.2	33.4	28.3	24.4	29.1	27.1	24	25.7	24.2	23.1	75
81	27.5	25.2	23.1	36	26.9	23.7	35.6	27.4	23.9	31.9	27.3	24	28	26.4	23.7	24.5	23.3	22.2	81
87	25.6	24.1	22.7	33.9	25.9	23.3	33.8	26.5	23.5	30.2	26.4	23.6	26.7	25.6	23.5	23.4	22.6	21.4	87
93	23.9	23	22.1	31.8	25.1	23	32.1	25.6	23.3	28.6	25.6	23.3	25.5	24.5	23	22.3	21.8	20.8	93
99	22.6	21.9	21.5	29.8	24.3	22.7	30.5	24.7	23	27.1	24.9	23.1	24.3	23.5	22.4	21.3	20.8	20	99
105	21.1	20.8	20.8	28.2	23.5	22.5	28.8	24.1	22.7	25.8	24.1	22.9	23	22.5	21.7	20.2	20	19.2	105
111	19.8	19.7	19.7	26.6	22.9	22.4	27.3	23.4	22.6	24.4	23.3	22.7	22	21.6	20.9	19.2	19.1	18.5	111
117	18.7	18.5	18.7	25.1	22.4	21.9	25.9	22.8	22.5	23.2	22.5	22	21	20.7	20.1	18.3	18.3	17.9	117
123	17.7	17.6	17.7	23.7	21.9	21.8	24.3	22.4	22.2	22.1	21.6	21.3	20	19.8	19.4	17.4	17.4	17.2	123
129	16.7	16.7	16.9	22.5	21.3	21.8	22.3	21.9	21.9	21	20.7	20.5	19	18.9	18.6	16.6	16.6	16.5	129
135	15.8	15.8	16	21.4	20.6	21.3	20.4	21.1	21.5	20	19.9	19.8	18.2	18	17.9	15.7	15.9	15.8	135
141	15	15	15.2	20	19.8	20.4	18.7	19.7	20.3	18.8	19	19	17.4	17.3	17.2	14.9	15.1	15.1	141
147	14.2	14.2		18.5	18.9	19.2	17.4	18	18.4	17.3	18	18.2	16.6	16.5	16.5	14.3	14.3	14.5	147
153	13.4			17	17.6	17.8	16.5	16.6	16.9	15.8	16.7	17.1	15.8	15.9	15.9	13.6	13.7	13.8	153
159				15.6	16.1		15.6	15.8	16	14.6	15.2	15.6	14.9	15.2	15.2	12.9	13.1	13.2	159
165				14.4	14.7		14.5	15	15.1	13.9	14	14.3	13.6	14.4	14.5	12.3	12.4	12.6	165
171							13.4	13.8		13.2	13.3	13.5	12.5	13.2	13.5	11.7	11.8	12	171
177							12.4	12.7		12.6	12.7	12.9	11.4	12.1	12.3	11.2	11.3	11.4	177
183							10.9	11.1		11.7	12.1	12.2	10.4	11	11.2	10.2	10.8	10.9	183
189										10.8	11.2		9.5	10	10.1	9.3	9.9	10.1	189
195										9.1			8.7	9.1	9.1	8.4	8.9	9.1	195
207													6.7			6.9	7.3	7.3	207

TAB 172312 / 172319 / 172326

# Lifting capacities on the hydraulically variable folding jib

## Capacités de levage à la fléchette pliante à variation hydraulique



ft	44 ft			58 ft			72 ft			86 ft			100 ft			114 ft			ft
	72 ft			72 ft			72 ft			72 ft			72 ft			72 ft			
	0°	22,5°	45°	0°	22,5°	45°	0°	22,5°	45°	0°	22,5°	45°	0°	22,5°	45°	0°	22,5°	45°	
12	23.4																		12
14	23.4			23.4															14
16	23.4			23.4			23												16
18	23.4			23.4			23			22.6									18
21	23.4			23.4			23			22.5			21.6						21
24	23.4			23.4			23			22.3			21.6			20.9			24
27	23.3			23.4			23			22.3			21.5			20.8			27
30	23.1			23.4			22.8			22			21.3			20.6			30
33	22.6			23.3			22.6			21.8			21.3			20.6			33
36	22.1			22.9			22.3			21.8			21.1			20.4			36
39	21.5	18.6		22.4			22			21.7			21			20.4			39
45	20.4	17.4		21.5	17.7		21.2	17.5		21.1			20.5			20.1			45
51	19.2	16.5		20.5	17		20.4	16.9		20.4	16.7		20	16.5		19.7			51
57	18.1	15.7		19.4	16.2		19.6	16.2		19.7	16.2		19.4	16.2		19.2	15.8		57
63	17	14.9	12.9	18.4	15.6	12.9	18.7	15.7	12.9	19	15.7		18.8	15.7		18.7	15.6		63
69	16	14.2	12.4	17.4	14.9	12.6	17.8	15.1	12.7	18.2	15.2	12.6	18.2	15.2	12.4	18.1	15.2		69
75	15	13.5	12.1	16.4	14.2	12.3	17	14.5	12.4	17.5	14.7	12.4	17.6	14.7	12.3	17.6	14.8	12.2	75
81	14	12.9	11.8	15.6	13.6	12.1	16.2	13.9	12.1	16.7	14.1	12.2	16.9	14.2	12.1	17.1	14.3	12.1	81
87	13.1	12.4	11.6	14.7	13.1	11.8	15.5	13.4	11.9	16	13.7	11.9	16.3	13.8	11.9	16.5	13.9	11.9	87
93	12.1	12	11.5	13.9	12.6	11.6	14.7	13	11.7	15.4	13.2	11.7	15.6	13.3	11.7	15.9	13.5	11.7	93
99	11.2	11.7		13	12.2	11.5	14.1	12.6	11.5	14.7	12.8	11.6	15.1	13	11.6	15.3	13.1	11.6	99
105				12.2	11.9	11.5	13.3	12.2	11.4	14.1	12.5	11.4	14.6	12.6	11.4	14.9	12.8	11.4	105
111				11.3	11.7	11.5	12.6	11.9	11.4	13.6	12.2	11.4	14	12.4	11.3	14.4	12.5	11.3	111
117				10.5	11.6		11.9	11.7	11.4	13	11.9	11.4	13.5	12.1	11.3	13.9	12.2	11.2	117
123							11.2	11.5	11.4	12.3	11.7	11.4	13	11.8	11.3	13.5	12	11.2	123
129							10.6	11.4		11.8	11.5	11.4	12.5	11.7	11.3	13.1	11.8	11.2	129
135										11.2	11.5	11.4	12	11.5	11.3	12.6	11.6	11.2	135
141										10.6	11.4		11.5	11.4	11.3	12.2	11.5	11.2	141
147													11	11.2	11.3	11.8	11.4	11.2	147
153													10.6	11		11.4	11.3	11.2	153
159													10.2			11	11.1	11.2	159
165																10.5	11		165
171																10.2			171
177																10			177

TAB 172312 / 172319 / 172326

# Lifting capacities on the hydraulically variable folding jib

## Capacités de levage à la fléchette pliante à variation hydraulique



ft	128 ft			142 ft			156 ft			171 ft			185 ft			197 ft			ft
	72 ft			72 ft			72 ft			72 ft			72 ft			72 ft			
	0°	22,5°	45°	0°	22,5°	45°	0°	22,5°	45°	0°	22,5°	45°	0°	22,5°	45°	0°	22,5°	45°	
27	19.9			20.6															27
30	19.9			20.6			19.6												30
33	19.6			20.6			19.6												33
36	19.6			20.6			19.6			18.2									36
39	19.6			20.6			19.6			18.2									39
45	19.4			20.2			19.4			18			16			14.6			45
51	19			19.8			19.1			17.8			16			14.6			51
57	18.6	15.5		19.4	16		18.8			17.6			16			14.6			57
63	18.2	15.2		19	15.9		18.4	15.3		17.3			16			14.4			63
69	17.8	14.9		18.5	15.5		18	15.2		17	14.5		15.8	13.6		14.3			69
75	17.3	14.6	12.2	18	15.1	12.1	17.6	14.9		16.7	14.4		15.5	13.5		14.2	12.6		75
81	16.8	14.2	12.1	17.6	14.7	12	17.2	14.5	11.9	16.4	14		15.3	13.4		14.1	12.6		81
87	16.3	13.8	11.9	17.1	14.3	11.9	16.8	14.1	11.8	16.1	13.7	11.6	15	13.1	11.2	14	12.6		87
93	15.9	13.5	11.7	16.7	13.9	11.8	16.4	13.8	11.6	15.7	13.4	11.6	14.7	12.9	11.2	13.8	12.4	10.9	93
99	15.4	13.2	11.5	16.2	13.6	11.7	16	13.5	11.6	15.3	13.1	11.4	14.4	12.6	11.2	13.6	12.2	10.9	99
105	14.9	12.8	11.4	15.7	13.3	11.5	15.5	13.2	11.4	15	12.8	11.3	14.2	12.4	11.1	13.4	12	10.9	105
111	14.4	12.6	11.3	15.2	12.9	11.4	15.1	12.9	11.3	14.6	12.6	11.2	13.9	12.2	11	13.2	11.8	10.8	111
117	14.1	12.3	11.2	14.8	12.7	11.3	14.7	12.6	11.2	14.3	12.4	11.1	13.6	12	10.9	13	11.7	10.7	117
123	13.7	12	11.1	14.4	12.4	11.2	14.3	12.4	11.1	14	12.2	11	13.3	11.8	10.8	12.7	11.5	10.7	123
129	13.3	11.8	11.1	14	12.2	11.1	14	12.2	11	13.7	12	10.9	13.1	11.7	10.8	12.5	11.4	10.6	129
135	12.9	11.7	11.1	13.6	12	11	13.6	12	11	13.3	11.8	10.9	12.9	11.5	10.8	12.2	11.2	10.6	135
141	12.4	11.5	11.1	13.2	11.8	10.9	13.3	11.8	11	13	11.6	10.9	12.6	11.4	10.7	11.9	11.1	10.6	141
147	12	11.3	11.1	12.9	11.6	10.9	13	11.6	11	12.8	11.5	10.9	12.4	11.2	10.7	11.6	10.9	10.6	147
153	11.6	11.1	11.1	12.6	11.4	10.9	12.7	11.4	10.9	12.5	11.3	10.9	12.1	11.1	10.7	11.2	10.8	10.6	153
159	11.1	10.9	11.1	12.3	11.3	10.9	12.4	11.3	10.9	12.3	11.2	10.9	11.8	11	10.7	10.9	10.6	10.6	159
165	10.7	10.6	11	12	11.2	10.9	12.1	11.2	10.9	12	11.1	10.9	11.6	10.9	10.7	10.5	10.3	10.4	165
171	10.2	10.3	10.6	11.6	11.1	10.9	11.9	11.1	10.9	11.8	11	10.9	11.3	10.7	10.7	10.1	10.1	10.2	171
177	9.8	9.9	10.1	11.3	10.9	10.9	11.7	11	10.9	11.5	10.9	10.9	11	10.6	10.7	9.6	9.9	10	177
183	9.3	9.4		11	10.9	10.9	11.3	11	10.9	11.2	10.8	10.9	10.7	10.4	10.7	9.2	9.5	9.8	183
189	8.9			10.6	10.9	10.3	11	10.9	10.9	10.3	10.7	10.9	10.4	10.3	10.6	8.8	9.1	9.4	189
195				10.3	10.9		10.6	10.7	10.9	9.7	10.3	10.6	9.7	10.1	10.4	8.4	8.7	9	195
207							9.1	9.6		8.9	9	9.3	8.1	9	9.4	7.6	7.9	8.2	207
219											8.2		6.7	7.4	7.6	6.4	7.1	7.3	219
231													6			5.2	5.9	5.9	231

TAB 172312 / 172319 / 172326

# Lifting heights Hauteurs de levage

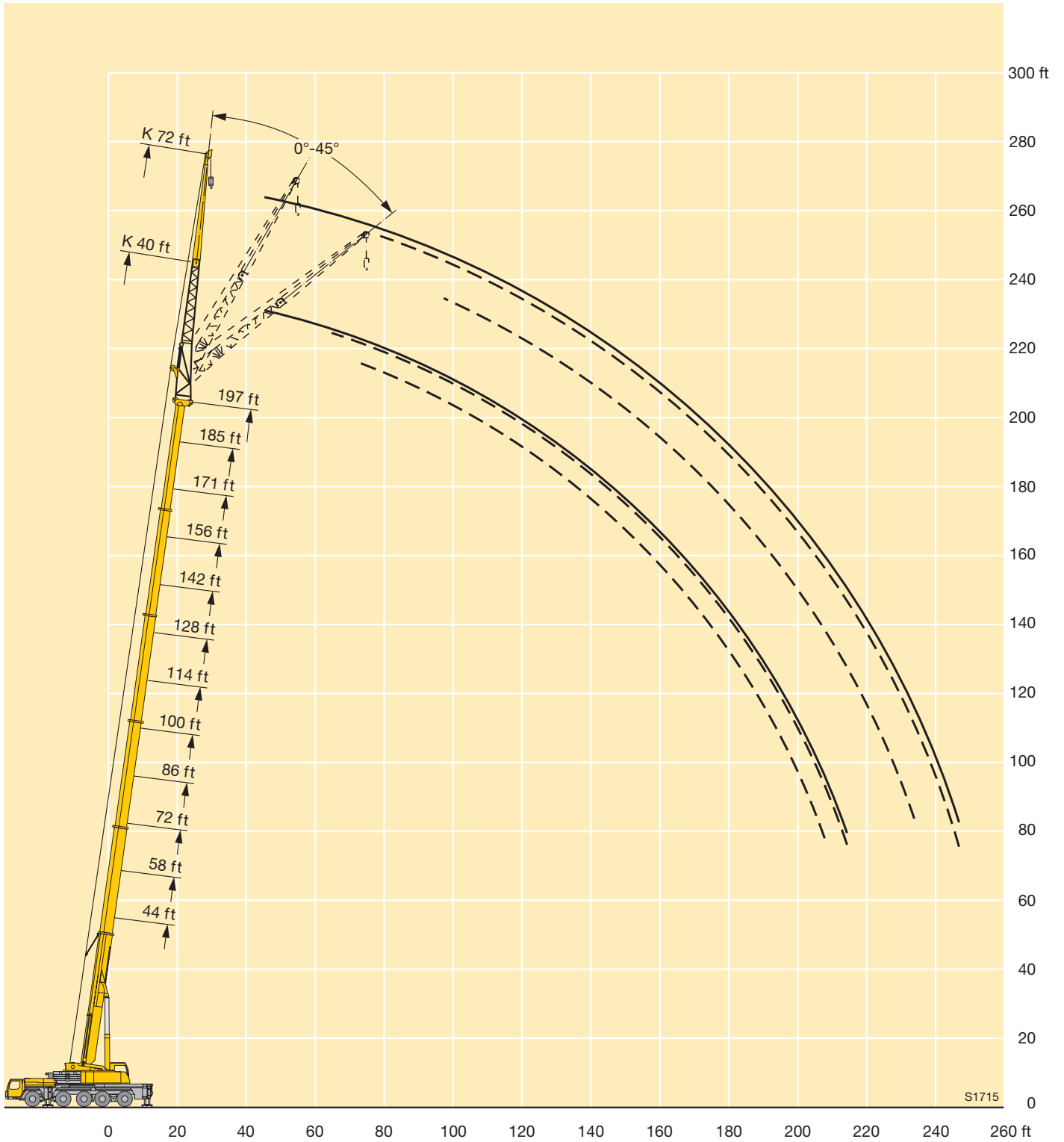

# Lifting capacities on the hydraulically variable folding jib

## Capacités de levage à la fléchette pliante à variation hydraulique



ft	44 ft			58 ft			72 ft			86 ft			100 ft			114 ft			ft
	95 ft			95 ft			95 ft			95 ft			95 ft			95 ft			
	0°	22,5°	45°	0°	22,5°	45°	0°	22,5°	45°	0°	22,5°	45°	0°	22,5°	45°	0°	22,5°	45°	
16	18.9			18.9															16
18	18.9			18.9			18												18
21	18.9			18.9			18			17.2									21
24	18.9			18.9			17.9			17.1			16.3						24
27	18.9			18.9			17.7			17			16.3			15.5			27
30	18.7			18.9			17.7			16.9			16.2			15.5			30
33	18.4			18.8			17.7			16.7			16			15.5			33
36	18.1			18.5			17.7			16.7			16			15.3			36
39	17.8			18.3			17.5			16.5			15.8			15.3			39
45	16.8			17.6			17			16.5			15.8			15.1			45
51	15.8	13		16.7			16.4			16.2			15.6			14.9			51
57	14.8	12.3		15.8	12.4		15.6	12.4		15.6			15.2			14.8			57
63	13.8	11.5		14.9	12		14.9	11.9		14.9	11.6		14.6	11.2		14.5			63
69	12.8	10.8		14	11.3		14.1	11.3		14.3	11.3		14.1	11		14	10.9		69
75	12	10.2		13.1	10.7		13.4	10.7		13.6	10.8		13.5	10.7		13.5	10.7		75
81	11.1	9.5	8.1	12.3	10.1	8	12.6	10.2	8	12.9	10.3		12.9	10.2		12.9	10.3		81
87	10.3	9	7.7	11.5	9.5	7.9	11.9	9.7	7.9	12.3	9.8	7.7	12.4	9.8	7.7	12.4	9.8		87
93	9.5	8.5	7.4	10.8	9.1	7.6	11.3	9.2	7.6	11.6	9.4	7.7	11.8	9.4	7.6	11.9	9.5	7.4	93
99	8.8	8.1	7.1	10	8.6	7.3	10.6	8.8	7.4	11.1	9	7.4	11.3	9.1	7.4	11.4	9.1	7.4	99
105	8.1	7.7	6.9	9.4	8.2	7.1	10	8.4	7.2	10.5	8.6	7.2	10.7	8.7	7.2	11	8.8	7.2	105
111	7.5	7.4	6.8	8.6	7.8	6.9	9.5	8.1	7	10	8.3	7.1	10.3	8.4	7.1	10.5	8.5	7.1	111
117	6.9	7.1	6.7	8	7.5	6.8	8.9	7.8	6.8	9.5	8	6.9	9.8	8.1	6.9	10.1	8.3	6.9	117
123	6.4	6.8		7.5	7.3	6.7	8.3	7.5	6.8	9	7.7	6.8	9.4	7.9	6.8	9.7	8	6.8	123
129	6			7	7	6.7	7.8	7.3	6.7	8.6	7.5	6.7	9	7.6	6.7	9.3	7.8	6.7	129
135				6.5	6.8		7.3	7.1	6.7	8.1	7.3	6.6	8.6	7.4	6.6	9	7.5	6.6	135
141				6.1			6.9	6.9	6.6	7.6	7.1	6.6	8.2	7.2	6.6	8.6	7.3	6.5	141
147							6.5	6.7		7.2	6.9	6.6	7.8	7	6.5	8.3	7.2	6.5	147
153							6.1			6.8	6.7	6.6	7.4	6.9	6.5	7.9	7	6.5	153
159										6.5	6.7		7	6.7	6.5	7.6	6.8	6.5	159
165										6.1			6.7	6.6	6.5	7.2	6.7	6.5	165
171													6.4	6.6		7	6.6	6.5	171
177													6.1	6.6		6.6	6.5	6.5	177
183													5.9			6.4	6.5	6.5	183
189																6.1	6.5		189
195																5.9			195

TAB 172312 / 172319 / 172326

# Lifting capacities on the hydraulically variable folding jib Capacités de levage à la fléchette pliante à variation hydraulique



ft	128 ft			142 ft			156 ft			171 ft			185 ft			197 ft			ft
	95 ft			95 ft			95 ft			95 ft			95 ft			95 ft			
	0°	22,5°	45°	0°	22,5°	45°	0°	22,5°	45°	0°	22,5°	45°	0°	22,5°	45°	0°	22,5°	45°	
30	14.6			15.5															30
33	14.6			15.5															33
36	14.6			15.5															36
39	14.3			15.5			14.6												39
45	14.3			15.4			14.6			13.3			11.9						45
51	14.3			15.3			14.5			13.3			11.9			10.7			51
57	14.3			15			14.4			13.2			11.7			10.7			57
63	14			14.7			14.1			13.1			11.6			10.7			63
69	13.6	10.4		14.3	11.1		13.8			12.9			11.6			10.7			69
75	13.2	10.4		13.9	10.9		13.5	10.2		12.7			11.6			10.6			75
81	12.7	10.1		13.5	10.5		13.1	10.1		12.3	9.7		11.4			10.5			81
87	12.3	9.8		13	10.2		12.7	9.9		12	9.6		11.1	9		10.4	8.5		87
93	11.8	9.4	7.3	12.6	9.8	7.3	12.3	9.7		11.7	9.4		10.9	8.9		10.2	8.5		93
99	11.4	9.1	7.3	12.1	9.5	7.3	11.9	9.4	7	11.4	9.1		10.6	8.7		9.9	8.2		99
105	11	8.8	7.2	11.7	9.2	7.3	11.6	9.1	7	11.1	8.8		10.4	8.5		9.7	8		105
111	10.6	8.5	7	11.3	8.9	7.1	11.2	8.8	7	10.8	8.6	6.8	10.1	8.3	6.6	9.5	8		111
117	10.2	8.3	6.9	10.9	8.6	7	10.8	8.6	6.9	10.4	8.4	6.8	9.9	8.1	6.6	9.3	7.8	6.3	117
123	9.8	8	6.8	10.5	8.3	6.9	10.5	8.3	6.8	10.1	8.1	6.7	9.6	7.9	6.6	9.1	7.6	6.3	123
129	9.5	7.8	6.7	10.1	8.1	6.8	10.1	8.1	6.7	9.8	8	6.6	9.4	7.7	6.5	8.9	7.5	6.3	129
135	9.1	7.6	6.6	9.7	7.9	6.7	9.8	7.9	6.6	9.6	7.8	6.5	9.1	7.5	6.4	8.7	7.3	6.3	135
141	8.8	7.4	6.5	9.4	7.7	6.6	9.4	7.7	6.6	9.3	7.6	6.5	8.9	7.4	6.3	8.5	7.2	6.2	141
147	8.5	7.2	6.5	9.1	7.5	6.5	9.1	7.5	6.5	9	7.4	6.4	8.7	7.2	6.3	8.3	7	6.2	147
153	8.2	7.1	6.4	8.8	7.3	6.4	8.9	7.3	6.4	8.7	7.2	6.3	8.4	7.1	6.2	8.1	6.9	6.1	153
159	7.9	6.9	6.4	8.4	7.1	6.4	8.6	7.2	6.3	8.5	7.1	6.3	8.2	6.9	6.2	8	6.8	6.1	159
165	7.6	6.8	6.4	8.2	7	6.4	8.3	7	6.3	8.3	6.9	6.2	8	6.8	6.1	7.8	6.7	6.1	165
171	7.3	6.6	6.4	7.9	6.8	6.4	8	6.9	6.3	8	6.8	6.2	7.8	6.7	6.1	7.6	6.5	6	171
177	7	6.6	6.4	7.7	6.7	6.4	7.8	6.8	6.3	7.8	6.7	6.1	7.7	6.6	6.1	7.4	6.5	6	177
183	6.8	6.5	6.4	7.4	6.6	6.3	7.6	6.6	6.3	7.6	6.6	6.1	7.5	6.5	6.1	7.2	6.4	6	183
189	6.6	6.3	6.4	7.1	6.5	6.3	7.4	6.5	6.3	7.4	6.5	6.1	7.3	6.4	6.1	7	6.3	6	189
195	6.3	6.3		6.9	6.4	6.3	7.2	6.5	6.3	7.2	6.4	6.1	7.1	6.3	6.1	6.8	6.2	6	195
207	5.9	6.3		6.4	6.3	6.3	6.7	6.3	6.3	6.9	6.2	6.1	6.8	6.2	6.1	6.4	6	6	207
219							6.3	6.2		6.5	6.1	6.1	6.6	6.1	6.1	5.9	5.9	6	219
231										6.1	5.9		5.7	6.1	6.1	5.2	5.5	5.8	231
243													4.6	5.4		4.3	5	5.2	243
255														4.2		3.3	4.1		255

TAB 172312 / 1721319 / 172326

# Lifting heights Hauteurs de levage

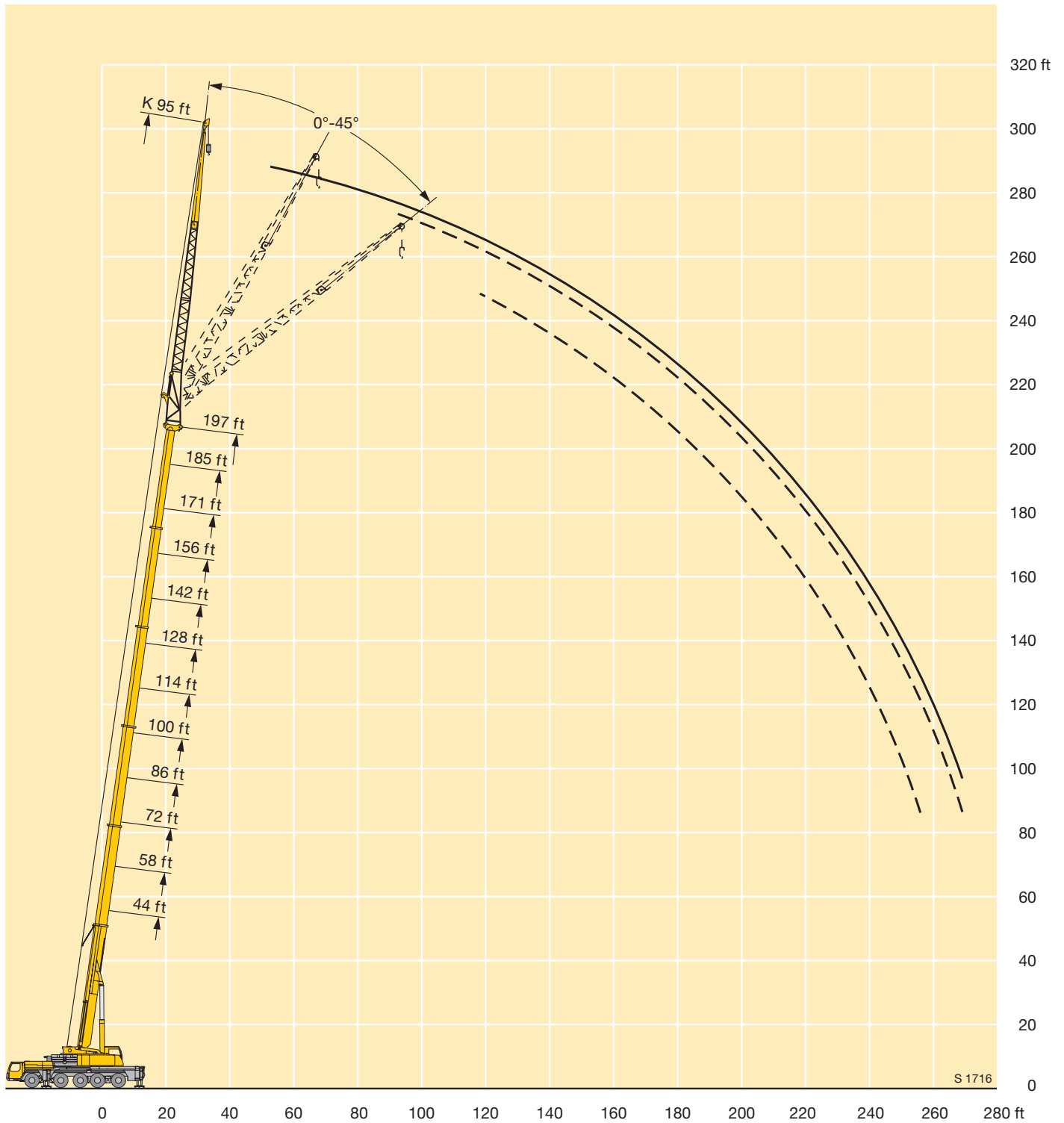

# Lifting capacities on the hydraulically variable folding jib

## Capacités de levage à la fléchette pliante à variation hydraulique



ft	44 ft			58 ft			72 ft			86 ft			100 ft			114 ft			ft
	118 ft			118 ft			118 ft			118 ft			118 ft			118 ft			
	0°	22,5°	45°	0°	22,5°	45°	0°	22,5°	45°	0°	22,5°	45°	0°	22,5°	45°	0°	22,5°	45°	
21	13.8			13.8															21
24	13.8			13.8			12.9												24
27	13.8			13.8			12.9			12.4			11.6						27
30	13.6			13.8			12.8			12.4			11.6			11.2			30
33	13.6			13.6			12.6			12.4			11.6			11.2			33
36	13.5			13.6			12.6			12.1			11.6			11.2			36
39	13.3			13.6			12.6			12.1			11.4			11.2			39
45	12.7			13.1			12.5			12.1			11.4			11			45
51	12			12.5			12.1			11.8			11.2			10.9			51
57	11.2			11.9			11.6			11.4			11			10.8			57
63	10.5	8.4		11.2			11			11			10.7			10.5			63
69	9.8	8.1		10.5	8		10.4	7.9		10.5			10.2			10.1			69
75	9.1	7.5		9.8	7.8		9.9	7.7		10	7.3		9.8	7.3		9.7			75
81	8.4	7		9.2	7.3		9.3	7.3		9.5	7.2		9.4	7.2		9.3	6.8		81
87	7.8	6.5		8.6	6.9		8.8	6.9		9	6.9		8.9	6.8		9	6.7		87
93	7.3	6.1	4.8	8	6.5	4.9	8.2	6.5		8.5	6.5		8.5	6.5		8.6	6.5		93
99	6.8	5.7	4.8	7.5	6.1	4.8	7.7	6.2	4.6	8	6.2	4.6	8.1	6.2		8.2	6.2		99
105	6.3	5.4	4.7	7	5.8	4.8	7.3	5.8	4.6	7.6	5.9	4.6	7.7	5.9		7.8	6		105
111	5.8	5.1	4.5	6.6	5.4	4.6	6.9	5.5	4.6	7.2	5.7	4.6	7.3	5.7	4.6	7.5	5.7		111
117	5.4	4.8	4.3	6.1	5.1	4.4	6.5	5.3	4.4	6.8	5.4	4.5	6.9	5.4	4.4	7.1	5.5	4.4	117
123	5	4.6	4.2	5.7	4.9	4.3	6.1	5	4.3	6.5	5.2	4.4	6.6	5.2	4.3	6.8	5.3	4.3	123
129	4.6	4.4	4.1	5.3	4.7	4.2	5.8	4.8	4.2	6.1	5	4.2	6.3	5	4.2	6.5	5.1	4.2	129
135	4.3	4.3	4	4.9	4.5	4.1	5.4	4.7	4.1	5.8	4.8	4.1	6	4.8	4.1	6.2	4.9	4.1	135
141	4	4.1	4	4.6	4.4	4	5.1	4.5	4.1	5.5	4.6	4.1	5.7	4.7	4.1	5.9	4.7	4.1	141
147	3.8	4.1		4.3	4.2	4	4.7	4.3	4	5.2	4.5	4	5.4	4.5	4	5.7	4.6	4	147
153				4	4.1		4.5	4.2	4	4.9	4.3	3.9	5.2	4.4	3.9	5.4	4.5	3.9	153
159				3.8	4		4.2	4.1	3.9	4.6	4.2	3.9	5	4.3	3.9	5.2	4.3	3.9	159
165							4	4		4.4	4.1	3.9	4.7	4.2	3.9	5	4.2	3.9	165
171							3.8	4		4.2	4	3.9	4.4	4.1	3.9	4.8	4.1	3.8	171
177							3.6	4		4	4	3.9	4.3	4	3.9	4.6	4	3.8	177
183										3.8	3.9		4.1	3.9	3.9	4.4	4	3.8	183
189										3.7	3.9		3.9	3.9	3.9	4.2	3.9	3.8	189
195													3.8	3.9		4	3.9	3.8	195
207													3.6			3.7	3.8		207

TAB 172312 / 172319 / 172326

# Lifting capacities on the hydraulically variable folding jib

## Capacités de levage à la fléchette pliante à variation hydraulique



ft	128 ft			142 ft			156 ft			171 ft			185 ft			197 ft			ft	
	118 ft			118 ft			118 ft			118 ft			118 ft			118 ft				
	0°	22,5°	45°	0°	22,5°	45°	0°	22,5°	45°	0°	22,5°	45°	0°	22,5°	45°	0°	22,5°	45°		
36	10.4																			36
39	10.4			11.2																39
45	10.2			11			10.4			9.5										45
51	10			10.9			10.2			9.5			8.3							51
57	9.9			10.8			10.2			9.5			8.3			7.3				57
63	9.9			10.6			10.1			9.4			8.3			7.3				63
69	9.8			10.3			9.9			9.2			8.2			7.3				69
75	9.5			10			9.7			9			8.2			7.3				75
81	9.1	6.8		9.6	7		9.4			8.8			8			7.3				81
87	8.8	6.7		9.3	7		9.1	6.6		8.5			7.8			7.2				87
93	8.4	6.4		9	6.7		8.7	6.5		8.2	6.1		7.6			7				93
99	8.1	6.1		8.6	6.4		8.5	6.3		8	6		7.4	5.6		6.9				99
105	7.8	5.9		8.3	6.1		8.2	6.1		7.7	5.8		7.2	5.6		6.7				105
111	7.5	5.7		8	5.9		7.9	5.8		7.5	5.6		7	5.4		6.5	5.1			111
117	7.1	5.4	4.4	7.6	5.7	4.4	7.6	5.6		7.3	5.4		6.8	5.1		6.3	4.9			117
123	6.9	5.3	4.3	7.3	5.5	4.4	7.3	5.4	4.1	7	5.3		6.6	5.1		6.2	4.9			123
129	6.6	5.1	4.2	7	5.3	4.3	7	5.3	4.1	6.7	5.1	4.1	6.4	5	3.9	6	4.8			129
135	6.3	4.9	4.1	6.7	5.1	4.2	6.7	5.1	4.1	6.5	5	4.1	6.2	4.8	3.9	5.8	4.7	3.6		135
141	6	4.8	4.1	6.4	5	4.1	6.5	5	4.1	6.3	4.8	4	6	4.7	3.9	5.7	4.6	3.6		141
147	5.8	4.6	4	6.2	4.8	4	6.2	4.8	4	6.1	4.7	3.9	5.8	4.6	3.9	5.5	4.5	3.6		147
153	5.5	4.5	3.9	5.9	4.7	4	6	4.7	3.9	5.9	4.6	3.9	5.6	4.5	3.8	5.4	4.4	3.6		153
159	5.3	4.4	3.9	5.7	4.6	3.9	5.8	4.5	3.9	5.7	4.5	3.8	5.4	4.4	3.8	5.2	4.3	3.6		159
165	5.1	4.3	3.8	5.5	4.4	3.9	5.6	4.4	3.8	5.5	4.4	3.8	5.3	4.3	3.7	5.1	4.2	3.6		165
171	4.9	4.2	3.8	5.3	4.3	3.8	5.3	4.3	3.8	5.3	4.3	3.7	5.1	4.2	3.7	4.9	4.1	3.6		171
177	4.7	4.1	3.8	5	4.2	3.8	5.1	4.2	3.7	5.1	4.2	3.7	4.9	4.1	3.6	4.8	4	3.6		177
183	4.6	4	3.8	4.9	4.1	3.8	5	4.1	3.7	4.9	4.1	3.7	4.8	4	3.6	4.7	3.9	3.6		183
189	4.4	3.9	3.8	4.7	4.1	3.8	4.8	4.1	3.7	4.8	4	3.6	4.7	4	3.6	4.6	3.9	3.6		189
195	4.2	3.9	3.8	4.6	4	3.7	4.6	4	3.7	4.6	4	3.6	4.6	3.9	3.6	4.4	3.8	3.4		195
207	4	3.7	3.8	4.3	3.9	3.7	4.4	3.8	3.6	4.4	3.8	3.6	4.3	3.8	3.6	4.2	3.7	3.4		207
219	3.7	3.6		4	3.6		4.1	3.6	3.6	4.2	3.7	3.6	4.1	3.7	3.6	4.1	3.6	3.4		219
231				3.8	3.6		3.9	3.6	3.6	4	3.7	3.6	4	3.5	3.6	3.9	3.5	3.4		231
243							3.7	3.6		3.8	3.6	3.6	3.8	3.4	3.6	3.7	3.5	3.4		243
255										3.6	3.6		3.4	3.4	3.6	3.2	3.4	3.4		255
267													2.8	3.2		3.1	3.2			267

TAB 172312 / 172319 / 172326

# Lifting heights Hauteurs de levage

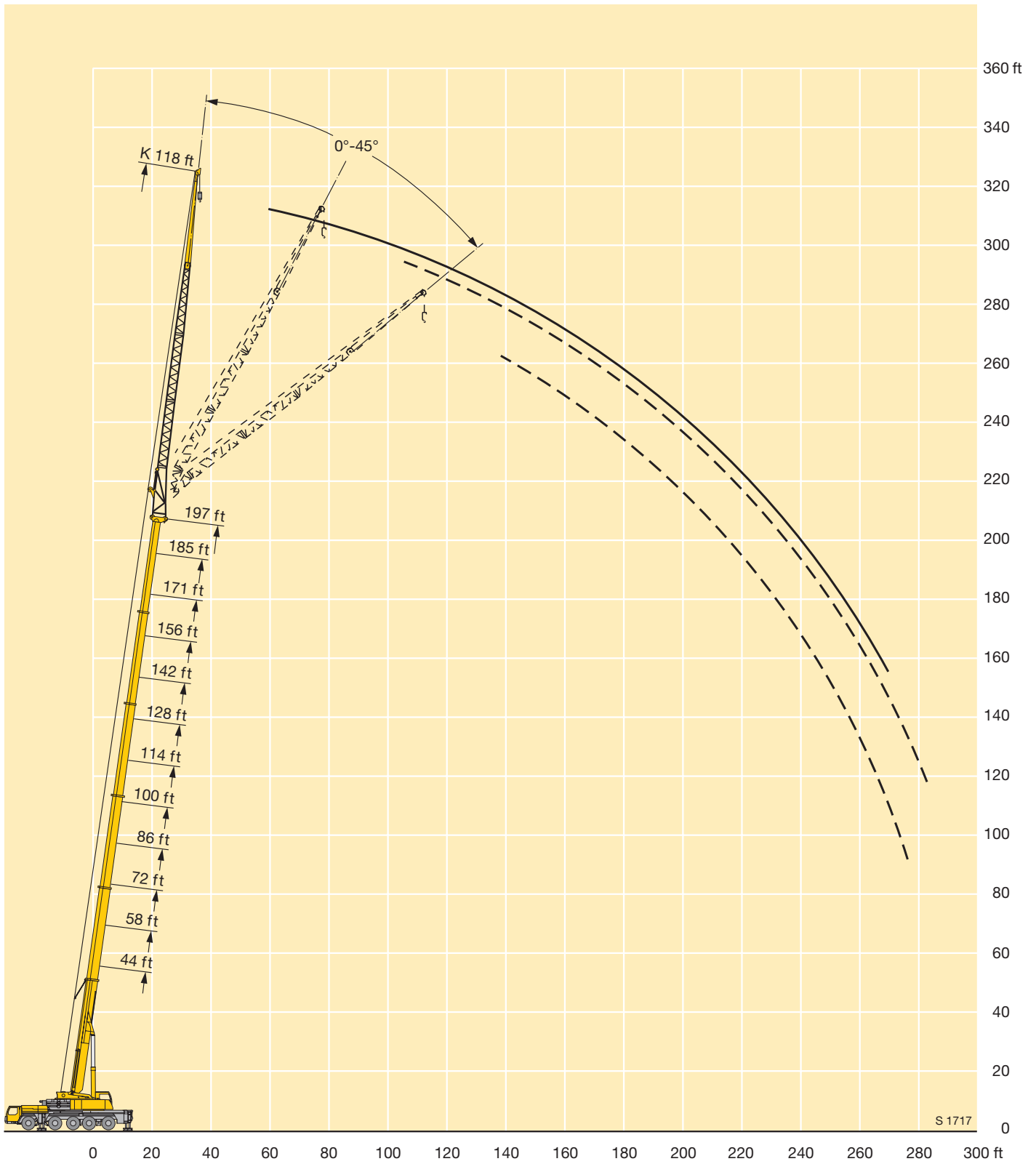

# Lifting capacities on the folding jib with boom extension

## Forces de levage à la fléchette pliante avec télescope rallongé



ft	44 ft + 23 ft			58 ft + 23 ft			72 ft + 23 ft			86 ft + 23 ft			100 ft + 23 ft			114 ft + 23 ft			ft
	40 ft			40 ft			40 ft			40 ft			40 ft			40 ft			
	0°	22,5°	45°	0°	22,5°	45°	0°	22,5°	45°	0°	22,5°	45°	0°	22,5°	45°	0°	22,5°	45°	
10	46.3																		10
12	46.3			46.3															12
14	46.3			46.3															14
16	46.3			46.3			46.3												16
18	46.3			46.3			46.3			46.3									18
21	46.3			46.3			46.3			46.3			41.8						21
24	46.3	42.5		46.3			46.3			46.2			41.7			38.4			24
27	46.3	41.9		46.3	40.8		46.3			45.6			41.3			38.3			27
30	46.1	39.6		46.2	40.5		46	37.9		44.3			40.7			38.1			30
33	45	37.5		45.6	38.6		44	37.8		42.9			39.8			37.7			33
36	42.1	35.7	25.7	43.5	36.7		42.1	36.2		41.5	35.7		38.9			37			36
39	39.8	34	25.7	41.3	35.3	25.7	40.3	34.9		39.9	34.5		37.8	33.1		36.2			39
45	35.7	31.2	25.7	37.3	32.5	25.7	37.2	32.5	25.7	37.1	32.3	25.7	35.6	31.4		34.7	30.5		45
51	32.2	28.9	24.9	34.1	30.2	25.3	34.2	30.2	25.5	34.6	30.4	25.7	33.3	29.7	25.7	32.9	29.3		51
57	29.3	26.8	24	31.2	28.1	24.5	31.4	28	24.8	32.3	28.6	25.2	31	28.2	25.2	31.1	27.9	24.7	57
63	26.7	24.9	23.1	28.8	26.3	23.7	28.6	25.9	23.9	30.1	26.8	24.4	28.6	26.7	24.3	29.2	26.6	24.1	63
69	24.5	23	22.2	26.6	24.6	23	26.3	24.1	22.9	28	25.1	23.4	26.5	25.1	23.4	27.3	25.4	23.2	69
75	22.6	21.3	21.3	24.6	23	22.2	24.3	22.5	21.8	26	23.6	22.4	24.7	23.5	22.4	25.5	24.1	22.4	75
81	20.8	19.8	20.2	23	21.5	21.2	22.4	21.1	20.6	24.3	22.2	21.3	22.9	22	21.4	23.9	22.7	21.6	81
87	19.1	18.5	18.9	21.5	20.2	20.3	20.7	19.8	19.5	22.7	21	20.3	21.2	20.6	20.3	22.4	21.3	20.6	87
93	17.6			20	19	19.4	19.4	18.6	18.5	21.2	19.9	19.4	20	19.3	19.2	21	20.2	19.7	93
99				18.7	18		18.1	17.6	17.6	20	18.9	18.6	18.7	18.2	18.1	19.8	19.1	18.8	99
105				17.4	17		17	16.6	16.8	18.9	17.9	17.8	17.5	17.2	17.2	18.8	18	17.9	105
111				16.4	16.4		15.9	15.7	16	17.8	17.2	17.1	16.6	16.2	16.3	17.7	17.2	17	111
117							15	14.9		16.8	16.4	16.5	15.6	15.3	15.4	16.7	16.3	16.3	117
123							14.2	14.2		16	15.7		14.7	14.6	14.7	15.9	15.5	15.5	123
129										15.2	15		14	13.8	14	15.2	14.8	14.9	129
135										14.6	14.5		13.3	13.1		14.4	14.2	14.3	135
141													12.6	12.5		13.7	13.6	13.7	141
147													12	12		13.2	13		147
153																12.6	12.5		153
159																12.1	12.1		159

TAB 172291 / 172298 / 172305

# Lifting capacities on the folding jib with boom extension

## Forces de levage à la fléchette pliante avec télescope rallongé



ft	128 ft + 23 ft			142 ft + 23 ft			156 ft + 23 ft			171 ft + 23 ft			185 ft + 23 ft			197 ft + 23 ft			ft
	40 ft			40 ft			40 ft			40 ft			40 ft			40 ft			
	0°	22,5°	45°	0°	22,5°	45°	0°	22,5°	45°	0°	22,5°	45°	0°	22,5°	45°	0°	22,5°	45°	
27	34.5																		27
30	34.4			32															30
33	34.2			32															33
36	34			31.8			27.9												36
39	33.6			31.7			27.9			25.7									39
45	32.5			31			27.9			25.7			21.6			18.9			45
51	31.3	27.9		30.3	27.3		27.9			25.7			21.6			18.9			51
57	30	27	23.8	29.3	26.5		27.6	24.3		25.5	22.8		21.6			18.9			57
63	28.6	25.9	23.4	28.1	25.5	22.6	26.8	23.8	21.6	25.3	22.7		21.6	21.1		18.9			63
69	27.1	24.9	22.7	26.9	24.6	22.2	25.9	23.2	21.4	24.8	22.3	19.9	21.4	20.9	18.7	18.9	19.2		69
75	25.5	23.8	22	25.7	23.6	21.6	25	22.4	20.9	24.1	21.8	19.7	21	20.5	18.5	18.9	19	16.3	75
81	24	22.7	21.3	24.3	22.7	21.1	24	21.7	20.2	23.3	21.2	19.3	20.5	20.3	18.1	18.6	18.5	16.2	81
87	22.5	21.5	20.5	23	21.7	20.4	22.8	20.9	19.6	22.5	20.5	18.7	20	19.8	17.7	18.2	17.9	15.9	87
93	21.2	20.4	19.7	21.7	20.7	19.7	21.7	20.1	19	21.6	19.8	18.2	19.5	19.2	17.2	17.7	17.4	15.7	93
99	19.9	19.3	18.8	20.6	19.7	19	20.6	19.3	18.4	20.7	19.1	17.7	18.9	18.6	16.8	17.2	16.7	15.5	99
105	18.6	18.4	18	19.5	18.8	18.2	19.6	18.5	17.9	19.7	18.5	17.2	18.4	18.1	16.4	16.6	16.2	15.2	105
111	17.6	17.4	17.3	18.4	18	17.5	18.7	17.8	17.3	18.8	17.8	16.8	17.8	17.5	16	16	15.6	14.8	111
117	16.7	16.5	16.5	17.4	17.1	16.8	17.8	17	16.8	18.1	17.1	16.3	17.3	16.9	15.6	15.4	15	14.5	117
123	15.7	15.7	15.7	16.6	16.3	16.2	16.9	16.4	16.2	17.3	16.5	15.9	16.7	16.3	15.2	14.8	14.5	14.1	123
129	14.8	14.8	15	15.8	15.6	15.5	16	15.7	15.6	16.5	15.8	15.4	16.1	15.7	14.9	14.2	14	13.7	129
135	14.1	14.1	14.2	14.9	14.9	14.9	15.2	15	15	15.7	15.2	15	15.5	15.2	14.5	13.6	13.5	13.3	135
141	13.4	13.4	13.5	14.2	14.2	14.2	14.5	14.4	14.4	15	14.6	14.5	14.9	14.7	14.2	13	12.9	12.9	141
147	12.7	12.7	12.9	13.6	13.5	13.6	13.7	13.7	13.8	14.3	14	14.1	14.3	14.1	13.9	12.4	12.4	12.5	147
153	12	12.1	12.2	13	12.9	13	12.9	13.1	13.2	13.7	13.5	13.6	13.7	13.6	13.5	11.9	12	12.1	153
159	11.5	11.5		12.4	12.4	12.5	12.4	12.5	12.6	13	13	13.1	13.2	13.1	13.2	11.3	11.5	11.6	159
165	10.9	11		11.8	11.8	11.9	11.7	11.9	12	12.4	12.4	12.6	12.7	12.6	12.7	10.9	11	11.2	165
171	10.4	10.4		11.3	11.3		11.1	11.3	11.5	11.9	11.9	12.1	12.1	12.1	12.3	10.4	10.5	10.7	171
177	9.9	10		10.9	10.9		10.5	10.8	10.9	11.4	11.4	11.6	11.6	11.7	11.8	9.9	10	10.2	177
183	7.1			10.4	10.5		10	10.2	10.3	10.8	10.9	11	11.2	11.2	11.4	9.4	9.6	9.8	183
189				10	10.1		9.5	9.7		10.3	10.4	10.6	10.4	10.8	10.9	9	9.1	9.3	189
195				7.6			9.1	9.2		9.9	10	10.1	9.5	10	10.2	8.6	8.7	8.9	195
207										9	9.2		7.9	8.4	8.5	7.7	8	8.1	207
219													6.5	6.9		6.3	6.7	6.8	219
231																5.1	5.4		231

TAB 172291 / 172298 / 172305

# Lifting capacities on the folding jib with boom extension

## Forces de levage à la fléchette pliante avec télescope rallongé



ft	44 ft + 23 ft			58 ft + 23 ft			72 ft + 23 ft			86 ft + 23 ft			100 ft + 23 ft			114 ft + 23 ft			ft
	63 ft			63 ft			63 ft			63 ft			63 ft			63 ft			
	0°	22,5°	45°	0°	22,5°	45°	0°	22,5°	45°	0°	22,5°	45°	0°	22,5°	45°	0°	22,5°	45°	
14	41.2																		14
16	41			37.4															16
18	40.8			37.2			32.7												18
21	40.3			36.9			32.7			30.3									21
24	39.6			36.5			32.7			30.3			27.2						24
27	38.4			36.2			32.4			30.3			27.2			24			27
30	36.7			35.6			32.1			30			27.2			24			30
33	35			34.3			31.8			29.8			27.1			24			33
36	33.4			33			31.1			29.5			26.9			24			36
39	31.9	26.3		31.7			30.2			29.2			26.6			23.8			39
45	28.8	24.5		29.3	24.7		28.3	24		27.7			26			23.6			45
51	26.3	22.8		27	23.4		26.5	22.7		26.1	21.8		24.9	21.2		23.2			51
57	24	21.2	18	24.9	21.8	18	24.8	21.4		24.7	21		23.7	20.4		22.5	19.7		57
63	21.9	19.6	17.5	23	20.5	17.6	23.1	20.2	17	23.3	20	17	22.6	19.5		21.8	19.1		63
69	20.1	18.1	16.8	21.2	19.2	17	21.6	19.1	16.8	21.9	19.1	16.8	21.4	18.6	16.3	21	18.3		69
75	18.4	16.8	16.2	19.6	18	16.4	20.1	18.1	16.3	20.6	18.1	16.3	20.3	17.8	16.1	20.2	17.7	15.6	75
81	16.8	15.6	15.4	18.2	17	15.7	18.7	17.1	15.7	19.4	17.3	15.7	19.2	17.1	15.5	19.3	17	15.4	81
87	15.6	14.5	14.5	16.9	16	15	17.6	16.2	15	18.2	16.5	15.1	18.2	16.4	15	18.5	16.3	14.9	87
93	14.4	13.6	13.7	15.7	15.1	14.2	16.5	15.4	14.4	17.1	15.8	14.5	17.2	15.7	14.4	17.6	15.7	14.4	93
99	13.4	12.8	13	14.7	14.2	13.6	15.4	14.5	13.8	16.2	15	14	16.2	15	14	16.8	15.1	13.9	99
105	12.5	12	12.4	13.7	13.4	13	14.5	13.8	13.2	15.3	14.3	13.5	15.3	14.4	13.5	16	14.5	13.5	105
111	11.6	11.3	11.9	12.9	12.7	12.5	13.6	13.1	12.7	14.4	13.7	13	14.4	13.8	13.1	15.2	14	13.1	111
117	10.8	10.7		12.1	12.1	12.1	12.8	12.4	12.2	13.8	13.1	12.6	13.6	13.2	12.7	14.5	13.5	12.7	117
123				11.4	11.5		12.1	11.8	11.7	13.1	12.5	12.2	12.8	12.6	12.3	13.7	13	12.4	123
129				10.7	11		11.5	11.3	11.3	12.5	12	11.8	12.1	12	11.8	13	12.5	12.1	129
135							10.9	10.8		11.9	11.6	11.5	11.5	11.4	11.4	12.4	12	11.7	135
141							10.3	10.4		11.4	11.1	11.2	10.8	10.9	10.9	11.8	11.4	11.4	141
147										10.9	10.7		10.3	10.3	10.4	11.3	11	11	147
153										10.4	10.4		9.8	9.8		10.7	10.5	10.6	153
159										10.1			9.3	9.4		10.2	10.1	10.2	159
165													8.8	8.9		9.8	9.6		165
171													8.4			9.4	9.3		171
177													8.2			8.9	8.9		177
183																8.6	8.6		183
189																8.3			189

TAB 172291 / 172298 / 172305

# Lifting capacities on the folding jib with boom extension

## Forces de levage à la fléchette pliante avec télescope rallongé



ft	128 ft + 23 ft			142 ft + 23 ft			156 ft + 23 ft			171 ft + 23 ft			185 ft + 23 ft			197 ft + 23 ft			ft
	63 ft			63 ft			63 ft			63 ft			63 ft			63 ft			
	0°	22,5°	45°	0°	22,5°	45°	0°	22,5°	45°	0°	22,5°	45°	0°	22,5°	45°	0°	22,5°	45°	
30	21.8																		30
33	21.8																		33
36	21.8			20.4															36
39	21.8			20.4			18.7												39
45	21.6			20.4			18.7			17.2			15.8						45
51	21.6			20.2			18.7			17.2			15.8			13.8			51
57	21.2			20.1			18.7			17.2			15.8			13.8			57
63	20.6	18.2		19.8	17.7		18.5			17.1			15.8			13.8			63
69	20.1	17.8		19.3	17.3		18.2	16.3		16.9	15.5		15.6			13.8			69
75	19.5	17.2	15	18.9	16.8		17.9	16.2		16.7	15.4		15.5	14.3		13.8			75
81	18.8	16.6	14.9	18.4	16.3	14.3	17.5	15.9	13.8	16.4	15.2		15.4	14.2		13.7	12.9		81
87	18.1	16	14.4	17.8	15.8	14.3	17.1	15.4	13.8	16.2	14.9	13.1	15.2	14		13.6	12.8		87
93	17.4	15.4	14	17.2	15.3	14	16.6	14.9	13.6	15.9	14.5	13.1	15	13.8	12.4	13.5	12.6	11.2	93
99	16.7	14.9	13.7	16.6	14.8	13.6	16.1	14.5	13.4	15.5	14.1	12.8	14.7	13.6	12.4	13.4	12.4	11.2	99
105	16	14.4	13.3	16	14.3	13.3	15.6	14	13	15.1	13.7	12.6	14.4	13.3	12.1	13.3	12.4	11.2	105
111	15.3	13.9	13	15.4	13.9	12.9	15.1	13.6	12.7	14.7	13.4	12.5	14.1	12.9	12.1	13	12.2	11.2	111
117	14.6	13.4	12.7	14.8	13.4	12.6	14.6	13.2	12.4	14.3	13	12.2	13.8	12.6	11.9	12.6	11.9	11	117
123	13.9	13	12.4	14.2	13	12.3	14.1	12.9	12.2	13.9	12.7	12	13.4	12.3	11.7	12.2	11.7	10.9	123
129	13.2	12.6	12.1	13.6	12.7	12	13.6	12.5	11.9	13.5	12.4	11.7	13.1	12.1	11.5	11.9	11.4	10.7	129
135	12.6	12.1	11.8	13	12.3	11.8	13.1	12.2	11.7	13	12	11.5	12.7	11.8	11.3	11.5	11.1	10.5	135
141	11.9	11.7	11.5	12.5	11.9	11.6	12.6	11.8	11.5	12.6	11.7	11.3	12.4	11.5	11.1	11.1	10.8	10.3	141
147	11.3	11.2	11.1	11.9	11.5	11.3	12.1	11.5	11.2	12.2	11.5	11.1	12	11.3	10.9	10.7	10.4	10.1	147
153	10.7	10.7	10.8	11.3	11.1	11	11.5	11.2	11	11.7	11.2	10.9	11.6	11	10.8	10.3	10.1	9.9	153
159	10.2	10.2	10.4	10.8	10.7	10.7	11	10.8	10.8	11.3	10.9	10.7	11.3	10.8	10.6	9.9	9.8	9.7	159
165	9.7	9.8	9.9	10.3	10.3	10.4	10.5	10.4	10.5	10.8	10.6	10.6	10.9	10.5	10.4	9.5	9.5	9.5	165
171	9.2	9.3	9.5	9.9	9.9	10	10	10.1	10.1	10.4	10.3	10.3	10.5	10.3	10.2	9	9.1	9.2	171
177	8.7	8.8	9	9.4	9.4	9.6	9.6	9.7	9.8	10	9.9	10	10.1	10	10	8.7	8.8	8.9	177
183	8.3	8.4		9	9	9.2	9.1	9.3	9.4	9.5	9.6	9.7	9.7	9.7	9.7	8.3	8.5	8.6	183
189	7.9	8		8.6	8.6	8.8	8.7	8.8	9	9.1	9.2	9.4	9.3	9.3	9.5	7.9	8.1	8.3	189
195	7.5	7.6		8.2	8.3		8.2	8.4	8.6	8.7	8.9	9	8.9	9	9.2	7.5	7.8	8	195
207				7.5	7.6		7.4	7.6	7.7	8	8.1	8.3	8.1	8.4	8.6	6.8	7	7.2	207
219							6.6	6.8		7.3	7.4	7.5	6.7	7.5	7.7	6.2	6.4	6.5	219
231										6.6	6.7		5.5	6.1		5.2	5.7	5.9	231
243													4.5	4.9		4.2	4.8		243
255																3.1	3.6		255

TAB 172291 / 172298 / 172305

# Lifting capacities on the folding jib with boom extension

## Forces de levage à la fléchette pliante avec télescope rallongé



ft	44 ft + 23 ft			58 ft + 23 ft			72 ft + 23 ft			86 ft + 23 ft			100 ft + 23 ft			114 ft + 23 ft			ft
	72 ft			72 ft			72 ft			72 ft			72 ft			72 ft			
	0°	22,5°	45°	0°	22,5°	45°	0°	22,5°	45°	0°	22,5°	45°	0°	22,5°	45°	0°	22,5°	45°	
14	23.3																		14
16	23.3			22.1															16
18	23.3			22.1			20.6												18
21	23.3			22.1			20.6			19.6									21
24	23.2			22.1			20.6			19.6			18.4						24
27	23			22.1			20.6			19.6			18.4			17.7			27
30	22.7			22			20.6			19.6			18.4			17.7			30
33	22.4			21.8			20.6			19.6			18.4			17.7			33
36	22.1			21.6			20.6			19.6			18.4			17.7			36
39	21.7			21.3			20.4			19.6			18.4			17.7			39
45	20.9	18.2		20.7	18		19.9			19.4			18.2			17.7			45
51	20.1	17.5		20	17.4		19.4	17		19			18			17.5			51
57	19.2	16.7		19.3	16.7		18.8	16.5		18.5	16.2		17.7	15.8		17.2			57
63	18.4	16	13.1	18.6	16	13.1	18.2	15.9		18	15.8		17.3	15.5		16.9	15.1		63
69	17.5	15.2	12.9	17.8	15.4	12.9	17.7	15.3	12.6	17.5	15.3		16.9	15.1		16.5	14.9		69
75	16.7	14.6	12.5	17.1	14.8	12.6	17.1	14.8	12.4	16.9	14.8	12.3	16.4	14.6	12.2	16.1	14.5		75
81	15.8	14	12.2	16.3	14.3	12.3	16.4	14.3	12.1	16.4	14.4	12.2	16	14.2	12.1	15.7	14.2	11.9	81
87	14.9	13.4	11.9	15.5	13.8	12	15.8	13.9	12	15.9	14	12	15.5	13.9	11.9	15.3	13.8	11.9	87
93	14	12.9	11.7	14.7	13.3	11.8	15.1	13.4	11.8	15.3	13.5	11.8	15	13.5	11.7	14.9	13.5	11.7	93
99	13	12.3	11.6	13.9	12.8	11.6	14.3	13	11.6	14.7	13.1	11.7	14.5	13.2	11.6	14.4	13.1	11.6	99
105	12.2	11.7	11.4	13.2	12.2	11.4	13.6	12.6	11.5	14.1	12.7	11.5	14.1	12.8	11.5	14	12.8	11.4	105
111	11.4	11	11	12.4	11.7	11.2	12.9	12	11.4	13.4	12.3	11.3	13.5	12.4	11.4	13.6	12.4	11.3	111
117	10.7	10.5	10.6	11.7	11.1	11	12.3	11.5	11.1	12.8	11.8	11.2	12.9	11.9	11.2	13.1	12	11.2	117
123	10	9.9		11.1	10.6	10.6	11.7	11	10.8	12.2	11.4	11	12.3	11.5	11	12.7	11.6	11	123
129	9.4			10.5	10.2	10.4	11.1	10.6	10.5	11.7	10.9	10.7	11.7	11.1	10.7	12.2	11.2	10.8	129
135				9.9	9.7		10.6	10.2	10.2	11.2	10.5	10.5	11.2	10.7	10.5	11.7	10.9	10.5	135
141				9.4			10.1	9.8		10.7	10.2	10.2	10.6	10.4	10.3	11.2	10.6	10.3	141
147							9.6	9.4		10.3	9.9	10.1	10.1	10	10	10.8	10.3	10.1	147
153							9.1			9.9	9.6		9.6	9.5	9.6	10.3	10	9.9	153
159										9.5	9.3		9.1	9.1	9.3	9.8	9.6	9.7	159
165										9.1			8.7	8.7		9.4	9.2	9.4	165
171													8.3	8.3		9	8.9	9.1	171
177													7.9	7.9		8.6	8.6	8.8	177
183													7.6	7.7		8.3	8.3		183
189																7.9	8		189
195																7.6	7.8		195

TAB 172291 / 172298 / 172305

# Lifting capacities on the folding jib with boom extension

## Forces de levage à la fléchette pliante avec télescope rallongé



ft	128 ft + 23 ft			142 ft + 23 ft			156 ft + 23 ft			171 ft + 23 ft			185 ft + 23 ft			197 ft + 23 ft			ft
	72 ft			72 ft			72 ft			72 ft			72 ft			72 ft			
	0°	22,5°	45°	0°	22,5°	45°	0°	22,5°	45°	0°	22,5°	45°	0°	22,5°	45°	0°	22,5°	45°	
30	16.5																		30
33	16.5																		33
36	16.5			15.8															36
39	16.5			15.8			14.8												39
45	16.5			15.8			14.8			13.8			12.9						45
51	16.5			15.8			14.8			13.8			12.9			11.4			51
57	16.3			15.7			14.8			13.8			12.9			11.4			57
63	16.1	14.8		15.5			14.7			13.8			12.9			11.4			63
69	15.8	14.6		15.3	14.2		14.6			13.7			12.8			11.4			69
75	15.5	14.2		15	14		14.4	13.3		13.6	12.9		12.7			11.4			75
81	15.2	13.9	11.6	14.8	13.7		14.1	13.3		13.5	12.8		12.6	12.1		11.4			81
87	14.8	13.5	11.6	14.5	13.4	11.4	13.9	13.1		13.3	12.6		12.6	12.1		11.4	10.9		87
93	14.5	13.3	11.6	14.2	13.1	11.4	13.7	12.9	11.2	13.1	12.6	10.9	12.4	12.1		11.3	10.9		93
99	14.1	13	11.5	13.8	12.9	11.4	13.4	12.6	11.2	12.9	12.3	10.9	12.3	11.9	10.7	11.2	10.9		99
105	13.7	12.6	11.4	13.5	12.6	11.2	13.1	12.3	11.2	12.7	12.1	10.9	12.1	11.6	10.7	11.1	10.9		105
111	13.4	12.3	11.2	13.2	12.2	11.2	12.9	12	10.9	12.5	11.8	10.9	11.9	11.4	10.7	11	10.7	9.9	111
117	13	11.9	11.1	12.9	11.9	11.1	12.6	11.7	10.9	12.2	11.5	10.8	11.7	11.1	10.5	10.9	10.5	9.9	117
123	12.6	11.6	10.9	12.5	11.5	10.9	12.3	11.4	10.7	12	11.2	10.6	11.5	10.9	10.4	10.7	10.3	9.9	123
129	12.1	11.2	10.7	12.2	11.2	10.7	12	11.1	10.5	11.7	10.9	10.4	11.4	10.6	10.2	10.5	10.1	9.8	129
135	11.7	10.9	10.5	11.8	10.9	10.5	11.7	10.8	10.4	11.5	10.7	10.2	11.2	10.4	10	10.4	9.9	9.6	135
141	11.3	10.6	10.3	11.5	10.6	10.3	11.4	10.5	10.2	11.2	10.4	10.1	10.9	10.2	9.8	10.2	9.7	9.5	141
147	10.8	10.3	10.1	11.1	10.4	10.1	11.1	10.3	10	10.9	10.2	9.9	10.7	10	9.7	10	9.5	9.3	147
153	10.4	10	9.9	10.7	10.1	9.9	10.7	10.1	9.8	10.7	10	9.7	10.4	9.8	9.6	9.7	9.4	9.2	153
159	9.9	9.8	9.7	10.3	9.8	9.7	10.4	9.8	9.7	10.4	9.7	9.6	10.2	9.6	9.4	9.4	9.2	9	159
165	9.5	9.5	9.6	9.9	9.6	9.6	10	9.6	9.5	10.1	9.6	9.5	10	9.4	9.3	9	8.9		165
171	9	9.1	9.3	9.5	9.4	9.4	9.7	9.3	9.4	9.8	9.3	9.3	9.7	9.2	9.2	8.7	8.7		171
177	8.5	8.7	8.8	9.1	9.1	9.2	9.3	9.1	9.2	9.5	9.1	9.2	9.4	9	9.1	8.4	8.4	8.5	177
183	8.1	8.3	8.5	8.7	8.8	8.9	8.9	8.9	9	9.2	8.9	9	9.1	8.8	9	8	8.1	8.3	183
189	7.8	7.9		8.3	8.4	8.6	8.5	8.6	8.8	8.8	8.7	8.8	8.9	8.6	8.9	7.7	7.8	8	189
195	7.4	7.5		8	8.1	8.3	8.1	8.3	8.5	8.5	8.5	8.7	8.6	8.5	8.7	7.3	7.6	7.8	195
207	6.7	6.8		7.4	7.4		7.3	7.5	7.7	7.8	7.9	8.1	8	8	8.3	6.7	6.9	7.2	207
219				6.7	6.9		6.6	6.8		7.1	7.3	7.5	7.1	7.5	7.8	6	6.3	6.5	219
231							5.9			6.5	6.7		5.9	6.6	6.8	5.5	5.7	5.9	231
243										5.9	6.1		4.9	5.3		4.5	5.1	5.2	243
255													3.8	4.3		3.5	4.1		255
267																2.5	3		267

TAB 172291 / 172298 / 172305

# Lifting heights Hauteurs de levage

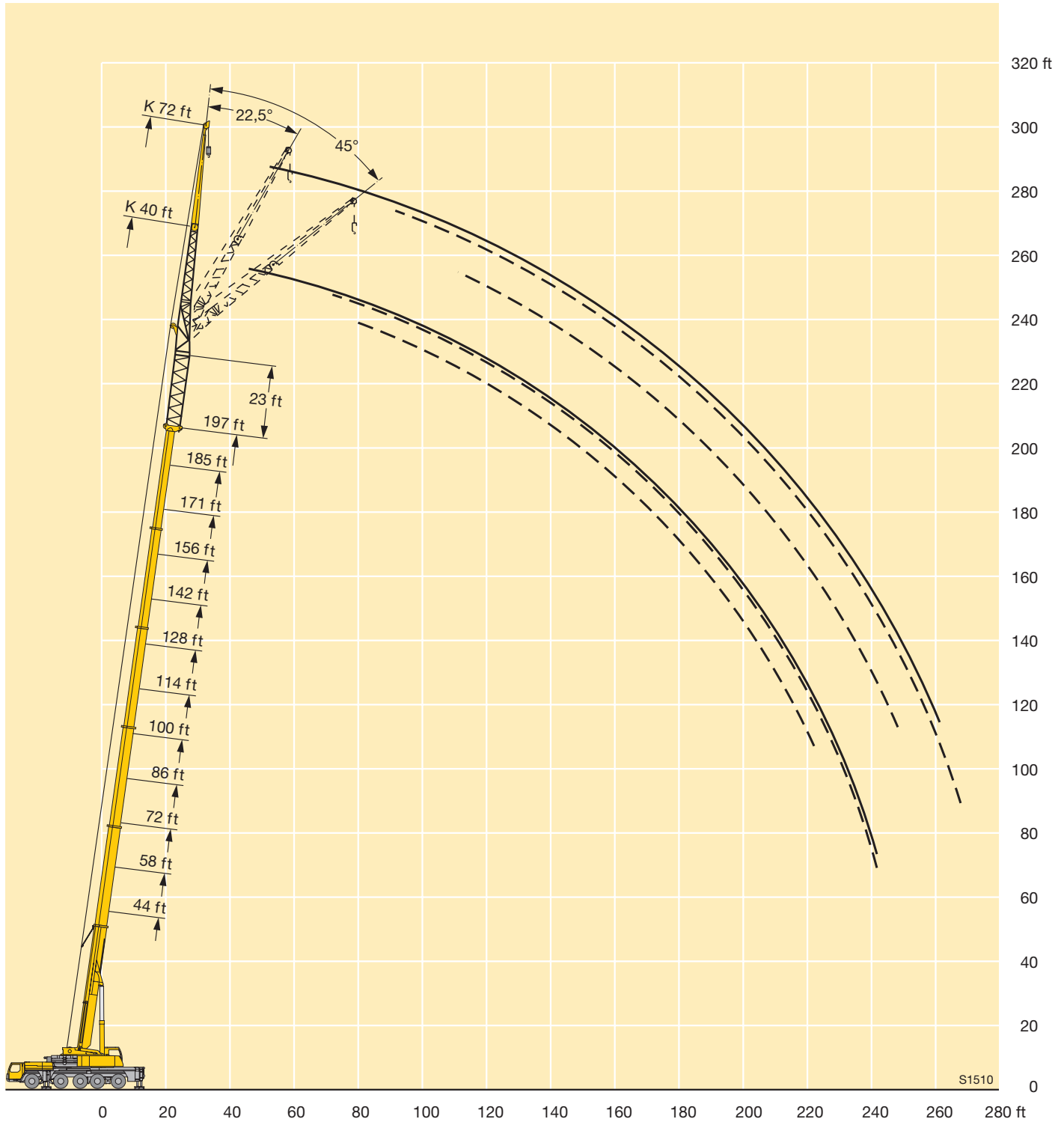

# Lifting capacities on the folding jib with boom extension

## Forces de levage à la fléchette pliante avec télescope rallongé



ft	44 ft + 23 ft			58 ft + 23 ft			72 ft + 23 ft			86 ft + 23 ft			100 ft + 23 ft			114 ft + 23 ft			ft
	86 ft			86 ft			86 ft			86 ft			86 ft			86 ft			
	0°	22,5°	45°	0°	22,5°	45°	0°	22,5°	45°	0°	22,5°	45°	0°	22,5°	45°	0°	22,5°	45°	
18	26			23															18
21	26			23			20.6												21
24	25.9			23			20.6			19.4									24
27	25.6			23			20.6			19.4			17.5						27
30	25.2			23			20.6			19.4			17.5			16.5			30
33	24.6			22.8			20.6			19.4			17.5			16.5			33
36	23.9			22.6			20.6			19.4			17.5			16.5			36
39	23.2			22.3			20.5			19.2			17.5			16.5			39
45	21.7			21.5			20			19			17.4			16.5			45
51	20.2	16		20.6			19.5			18.6			17.2			16.3			51
57	18.7	15.2		19.5	14.9		18.7	14.6		18.1			16.9			16.1			57
63	17.3	14.3		18.3	14.3		17.8	14		17.5	13.6		16.6			15.8			63
69	16	13.4		17.2	13.5		16.9	13.3		16.7	13.3		16.1	12.7		15.5	12.4		69
75	14.8	12.6	9.8	16.1	12.8	9.8	16	12.7		15.9	12.7		15.4	12.5		15	12.2		75
81	13.7	11.9	9.6	15	12.2	9.6	15.1	12.1	9.2	15.1	12.2	9.2	14.7	12		14.5	11.7		81
87	12.7	11.3	9.3	14	11.6	9.3	14.2	11.6	9.2	14.4	11.7	9.2	14	11.5	9	13.9	11.3		87
93	11.7	10.7	9	13.2	11	9	13.4	11.1	9	13.6	11.2	9	13.4	11.1	8.9	13.3	11.1	8.7	93
99	10.8	10.2	8.7	12.3	10.5	8.8	12.6	10.6	8.8	12.9	10.8	8.8	12.8	10.7	8.7	12.8	10.7	8.7	99
105	10.1	9.7	8.4	11.4	10	8.5	11.9	10.2	8.6	12.2	10.4	8.6	12.2	10.4	8.5	12.3	10.4	8.5	105
111	9.3	9.3	8.3	10.8	9.7	8.3	11.2	9.8	8.4	11.6	10	8.4	11.6	10	8.4	11.7	10.1	8.4	111
117	8.7	8.8	8.1	10.1	9.3	8.2	10.5	9.4	8.2	11	9.7	8.2	11.1	9.7	8.2	11.2	9.8	8.2	117
123	8.1	8.3	8	9.5	8.9	8.1	10	9.1	8.1	10.4	9.3	8.1	10.6	9.4	8.1	10.7	9.5	8.1	123
129	7.6	7.9	7.9	8.9	8.4	8	9.5	8.7	8	9.9	9	8	10.1	9	8	10.3	9.2	8	129
135	7.1	7.5		8.4	8	7.9	8.9	8.3	7.9	9.4	8.6	7.9	9.7	8.7	7.9	9.9	8.9	7.9	135
141	6.7			7.9	7.6	7.7	8.5	8	7.8	9	8.3	7.8	9.2	8.4	7.8	9.5	8.6	7.8	141
147				7.5	7.3		8.1	7.7	7.7	8.6	8	7.7	8.8	8.1	7.7	9.1	8.3	7.8	147
153				7			7.7	7.4		8.2	7.7	7.6	8.4	7.8	7.6	8.7	8	7.7	153
159							7.3	7.1		7.8	7.4	7.5	8	7.5	7.5	8.4	7.7	7.5	159
165							6.9			7.5	7.2		7.6	7.3	7.4	8.1	7.5	7.4	165
171										7.1	7		7.2	7.1	7.2	7.7	7.3	7.3	171
177										6.8	6.8		6.9	6.8	7	7.4	7.1	7.2	177
183										6.6	6.8		6.5	6.5		7.1	6.9	7.1	183
189													6.2	6.2		6.8	6.7	6.9	189
195													5.9	6		6.5	6.5		195
207																5.9	6.1		207

TAB 172291 / 172298 / 172305

# Lifting capacities on the folding jib with boom extension

## Forces de levage à la fléchette pliante avec télescope rallongé



ft	128 ft + 23 ft			142 ft + 23 ft			156 ft + 23 ft			171 ft + 23 ft			185 ft + 23 ft			197 ft + 23 ft			ft
	86 ft			86 ft			86 ft			86 ft			86 ft			86 ft			
	0°	22,5°	45°	0°	22,5°	45°	0°	22,5°	45°	0°	22,5°	45°	0°	22,5°	45°	0°	22,5°	45°	
36	15																		36
39	15			14.3															39
45	15			14.3			13.1			12.1									45
51	15			14.3			13.1			12.1			11.2						51
57	15			14.3			13.1			12.1			11.2			9.7			57
63	14.8			14.2			13.1			12.1			11.2			9.7			63
69	14.5			14			13			12.1			11.1			9.7			69
75	14.2	11.6		13.7	11.6		12.8			12			11			9.7			75
81	13.8	11.6		13.4	11.5		12.6	10.7		11.9	10.4		10.9			9.7			81
87	13.4	11.3		13.1	11.1		12.4	10.7		11.7	10.4		10.9	9.7		9.7			87
93	12.9	10.9	8.5	12.7	10.8		12.1	10.6		11.4	10.2		10.7	9.7		9.6	8.7		93
99	12.5	10.6	8.5	12.3	10.5	8.4	11.8	10.3	8	11.2	10.1		10.6	9.7		9.5	8.7		99
105	12	10.3	8.3	11.9	10.2	8.4	11.5	10	8	11	9.9		10.5	9.5		9.4	8.7		105
111	11.6	10	8.3	11.5	9.9	8.2	11.1	9.8	8	10.7	9.6	7.8	10.3	9.3		9.3	8.5		111
117	11.1	9.7	8.1	11.1	9.7	8.1	10.8	9.5	8	10.4	9.3	7.8	10	9.1	7.8	9.2	8.5	7.3	117
123	10.7	9.4	8	10.7	9.4	8	10.5	9.3	7.9	10.2	9.1	7.8	9.8	8.8	7.7	9	8.3	7.3	123
129	10.3	9.1	7.9	10.4	9.1	7.9	10.1	9	7.8	9.9	8.8	7.7	9.5	8.6	7.6	8.8	8.1	7.3	129
135	9.9	8.8	7.9	10	8.8	7.8	9.8	8.8	7.7	9.6	8.6	7.6	9.3	8.4	7.5	8.6	7.9	7.3	135
141	9.5	8.6	7.8	9.6	8.6	7.7	9.5	8.5	7.7	9.3	8.4	7.6	9	8.2	7.5	8.4	7.7	7.2	141
147	9.2	8.3	7.7	9.3	8.3	7.7	9.2	8.2	7.6	9.1	8.2	7.5	8.8	8	7.4	8.2	7.6	7.1	147
153	8.8	8	7.6	9	8.1	7.6	8.9	8	7.5	8.8	8	7.4	8.5	7.8	7.3	8	7.4	7	153
159	8.5	7.8	7.5	8.7	7.9	7.5	8.6	7.8	7.4	8.5	7.7	7.3	8.4	7.6	7.2	7.8	7.3	6.9	159
165	8.2	7.6	7.4	8.4	7.6	7.4	8.4	7.6	7.3	8.3	7.6	7.2	8.1	7.4	7.1	7.5	7.1	6.8	165
171	7.8	7.4	7.3	8.1	7.4	7.3	8.1	7.4	7.2	8.1	7.4	7.1	7.9	7.2	7	7.3	7	6.8	171
177	7.5	7.1	7.2	7.8	7.2	7.2	7.9	7.2	7.1	7.9	7.2	7	7.7	7.1	6.9	7.1	6.8	6.7	177
183	7.1	6.9	7	7.5	7.1	7.1	7.6	7.1	7	7.6	7	6.9	7.5	6.9	6.8	6.9	6.6	6.6	183
189	6.8	6.7	6.9	7.2	6.9	7	7.3	6.9	6.9	7.5	6.9	6.8	7.4	6.8	6.8	6.7	6.5	6.5	189
195	6.5	6.4	6.7	6.9	6.7	6.8	7	6.8	6.9	7.2	6.7	6.8	7.2	6.6	6.7	6.4	6.3	6.4	195
207	5.8	5.9		6.4	6.3	6.5	6.4	6.4	6.6	6.7	6.5	6.7	6.8	6.4	6.6	5.8	5.9	6.1	207
219	5.3	5.4		5.8	5.8		5.8	5.9	6.1	6.2	6.1	6.4	6.4	6.2	6.5	5.2	5.4	5.7	219
231				5.3			5.2	5.4		5.6	5.7	6	5.6	5.9	6.2	4.7	4.9	5.1	231
243							4.6			5.1	5.3		4.6	5.3	5.6	4.2	4.4	4.6	243
255										4.6	4.8				4.3	3.2	4	4.1	255
267															2.6	2.9			267

TAB 172291 / 172298 / 172305

# Lifting heights Hauteurs de levage

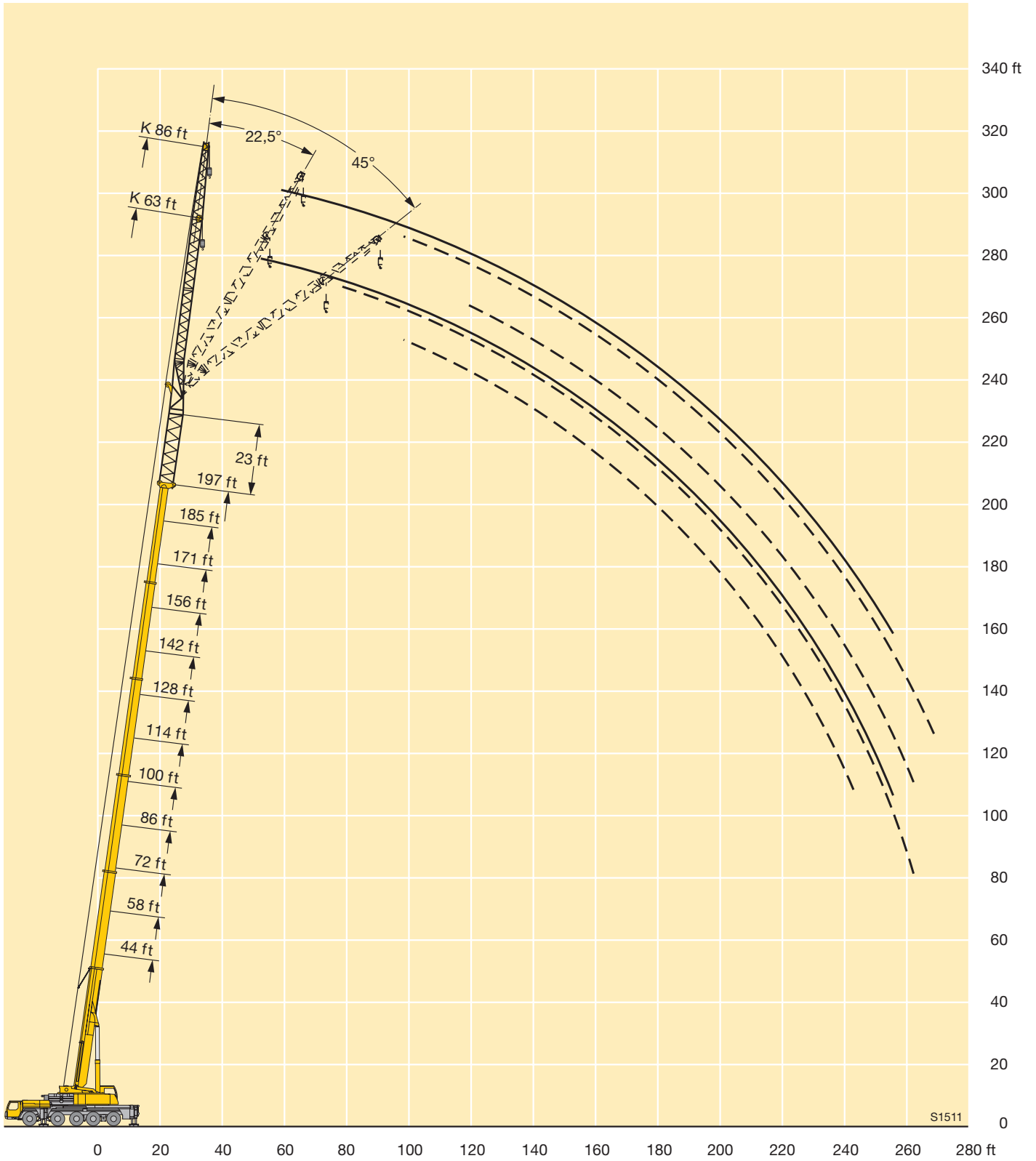

# Lifting capacities on the folding jib with boom extension

## Forces de levage à la fléchette pliante avec télescope rallongé



ft	44 ft + 23 ft			58 ft + 23 ft			72 ft + 23 ft			86 ft + 23 ft			100 ft + 23 ft			114 ft + 23 ft			ft
	95 ft			95 ft			95 ft			95 ft			95 ft			95 ft			
	0°	22,5°	45°	0°	22,5°	45°	0°	22,5°	45°	0°	22,5°	45°	0°	22,5°	45°	0°	22,5°	45°	
18	17.2																		18
21	17.2			16.5															21
24	17.2			16.5			15.3			14.6									24
27	17.2			16.5			15.3			14.6			13.6						27
30	17.2			16.5			15.3			14.6			13.6			12.9			30
33	17.2			16.5			15.3			14.6			13.6			12.9			33
36	17.2			16.5			15.3			14.6			13.6			12.9			36
39	17.1			16.4			15.3			14.6			13.6			12.9			39
45	16.6			16.1			15.1			14.5			13.6			12.9			45
51	16			15.7			14.9			14.3			13.5			12.9			51
57	15.3	12.7		15.2	12.6		14.6			14.1			13.3			12.8			57
63	14.6	12.2		14.6	12.2		14.1	11.6		13.8			13.2			12.7			63
69	13.9	11.5		13.9	11.5		13.6	11.3		13.4	11		12.9	10.8		12.5			69
75	13.1	10.9		13.3	11		13.1	10.8		13	10.8		12.6	10.5		12.3	10.2		75
81	12.4	10.3	8	12.7	10.4	8.1	12.6	10.4		12.5	10.3		12.2	10.1		12	10		81
87	11.7	9.8	8	12	10	8	12	9.9	7.7	12.1	9.9		11.8	9.8		11.6	9.6		87
93	11.1	9.4	7.8	11.4	9.5	7.8	11.5	9.5	7.7	11.6	9.6	7.5	11.4	9.5	7.3	11.3	9.4		93
99	10.4	8.9	7.5	10.9	9.1	7.5	11	9.2	7.5	11.1	9.2	7.5	11	9.1	7.3	11	9.1	7	99
105	9.8	8.5	7.3	10.3	8.7	7.3	10.5	8.8	7.3	10.7	8.9	7.3	10.6	8.9	7.3	10.6	8.8	7	105
111	9.2	8.1	7.1	9.8	8.4	7.1	10	8.5	7.1	10.3	8.6	7.1	10.2	8.6	7.1	10.3	8.6	7	111
117	8.6	7.8	6.9	9.3	8.1	7	9.6	8.2	7	9.8	8.3	7	9.9	8.3	7	9.9	8.3	6.9	117
123	8.1	7.5	6.8	8.8	7.8	6.9	9.1	7.9	6.9	9.4	8	6.9	9.5	8.1	6.9	9.6	8.1	6.8	123
129	7.6	7.3	6.7	8.3	7.5	6.8	8.7	7.6	6.7	9	7.8	6.8	9.1	7.8	6.7	9.3	7.9	6.7	129
135	7.1	7	6.7	7.9	7.2	6.7	8.3	7.4	6.7	8.6	7.6	6.7	8.8	7.6	6.6	8.9	7.7	6.6	135
141	6.6	6.7		7.4	7	6.7	7.9	7.2	6.6	8.3	7.3	6.6	8.4	7.4	6.6	8.6	7.5	6.6	141
147	6.2	6.4		7	6.8	6.7	7.5	7	6.6	7.9	7.2	6.6	8.1	7.2	6.5	8.3	7.3	6.5	147
153				6.6	6.5		7.1	6.7	6.6	7.6	7	6.5	7.7	7	6.5	7.9	7.1	6.5	153
159				6.3	6.3		6.8	6.5		7.2	6.7	6.5	7.5	6.8	6.5	7.6	6.9	6.4	159
165							6.5	6.3		6.9	6.5	6.5	7.2	6.7	6.5	7.4	6.7	6.4	165
171							6.2	6.1		6.6	6.3		6.9	6.5	6.5	7.1	6.6	6.4	171
177							5.9	6		6.3	6.2		6.6	6.3	6.4	6.9	6.4	6.4	177
183										6.1	6		6.3	6.1	6.3	6.6	6.3	6.4	183
189										5.8	5.9		6	5.9		6.4	6.1	6.3	189
195													5.7	5.7		6.1	5.9	6.3	195
207													5.3			5.7	5.7		207
219																5.3			219

TAB 172291 / 172298 / 172305

# Lifting capacities on the folding jib with boom extension

## Forces de levage à la fléchette pliante avec télescope rallongé



ft	128 ft + 23 ft			142 ft + 23 ft			156 ft + 23 ft			171 ft + 23 ft			185 ft + 23 ft			197 ft + 23 ft		ft
	95 ft			95 ft			95 ft			95 ft			95 ft			95 ft		
	0°	22,5°	45°	0°	22,5°	45°	0°	22,5°	45°	0°	22,5°	45°	0°	22,5°	45°	0°	22,5°	
36	12.1																	36
39	12.1			11.4														39
45	12.1			11.4			10.7											45
51	12.1			11.4			10.7			9.9			9.2					51
57	12.1			11.4			10.7			9.9			9.2			8		57
63	12			11.4			10.7			9.9			9.2			8		63
69	11.9			11.4			10.7			9.9			9.2			8		69
75	11.7	10		11.3			10.6			9.9			9.2			8		75
81	11.5	9.8		11.1	9.5		10.5			9.9			9.2			8		81
87	11.3	9.4		11	9.4		10.4	9		9.9	8.5		9.2			8		87
93	11	9.3		10.8	9.2		10.3	8.9		9.8	8.5		9.1	8		8		93
99	10.7	9	7.1	10.5	8.9		10.1	8.7		9.7	8.5		9.1	8		8	7.3	99
105	10.4	8.7	7.1	10.3	8.7		9.9	8.5		9.6	8.3		9	8		8	7.3	105
111	10.1	8.5	7	10	8.4	6.8	9.7	8.3	6.6	9.4	8.1		9	7.8		8	7.3	111
117	9.8	8.2	6.9	9.7	8.2	6.8	9.4	8.1	6.6	9.2	8	6.3	8.8	7.7		8	7.1	117
123	9.5	8	6.8	9.5	8	6.7	9.2	7.9	6.6	8.9	7.8	6.3	8.6	7.6		7.9	7	123
129	9.2	7.8	6.7	9.2	7.8	6.6	9	7.7	6.5	8.7	7.6	6.3	8.4	7.4	6.3	7.8	7	129
135	8.9	7.6	6.6	8.9	7.7	6.5	8.7	7.6	6.5	8.5	7.4	6.3	8.2	7.3	6.3	7.6	7	135
141	8.6	7.5	6.5	8.6	7.5	6.5	8.5	7.4	6.4	8.3	7.3	6.3	8	7.1	6.2	7.4	6.9	141
147	8.3	7.3	6.5	8.3	7.3	6.4	8.2	7.3	6.4	8.1	7.2	6.3	7.8	7	6.2	7.2	6.8	147
153	8	7.1	6.4	8	7.1	6.4	8	7.1	6.3	7.8	7	6.2	7.6	6.9	6.1	7.1	6.6	153
159	7.7	7	6.4	7.8	7	6.3	7.7	7	6.3	7.6	6.9	6.2	7.4	6.8	6.1	6.9	6.5	159
165	7.5	6.8	6.3	7.6	6.8	6.3	7.5	6.8	6.2	7.4	6.8	6.1	7.3	6.6	6.1	6.8	6.4	165
171	7.2	6.6	6.3	7.3	6.7	6.3	7.3	6.6	6.2	7.2	6.6	6.1	7.1	6.5	6	6.6	6.2	171
177	7	6.5	6.3	7.1	6.5	6.3	7.1	6.5	6.2	7	6.5	6.1	6.9	6.4	6	6.5	6.1	177
183	6.7	6.3	6.3	6.8	6.4	6.2	6.9	6.3	6.2	6.9	6.3	6.1	6.7	6.2	6	6.4	6	183
189	6.5	6.1	6.2	6.6	6.2	6.2	6.7	6.2	6.1	6.7	6.2	6	6.6	6.1	6	6.2	5.9	189
195	6.2	6	6.2	6.4	6.1	6.1	6.5	6.1	6.1	6.5	6	6	6.4	6	5.9	6.1	5.8	195
207	5.7	5.7		6	5.8	6	6	5.8	6	6.2	5.8	5.9	6.1	5.7	5.8	5.6	5.6	207
219	5.1	5.3		5.6	5.6		5.6	5.5	5.8	5.8	5.6	5.8	5.8	5.5	5.8	5.1	5.3	219
231				5.1	5.2		5.1	5.2	5.5	5.4	5.3	5.6	5.5	5.3	5.7	4.5	4.8	231
243							4.6	4.8		5	5.1	5.4	4.9	5.1	5.5	4.1	4.4	243
255							4.2	4.3		4.6	4.7		3.9	4.7	4.9	3.5	4	255
267										4.1	4.4		2.9	3.7		2.6	3.4	267
279													2.6				2.4	279

TAB 172291 / 172298 / 172305

# Lifting heights Hauteurs de levage

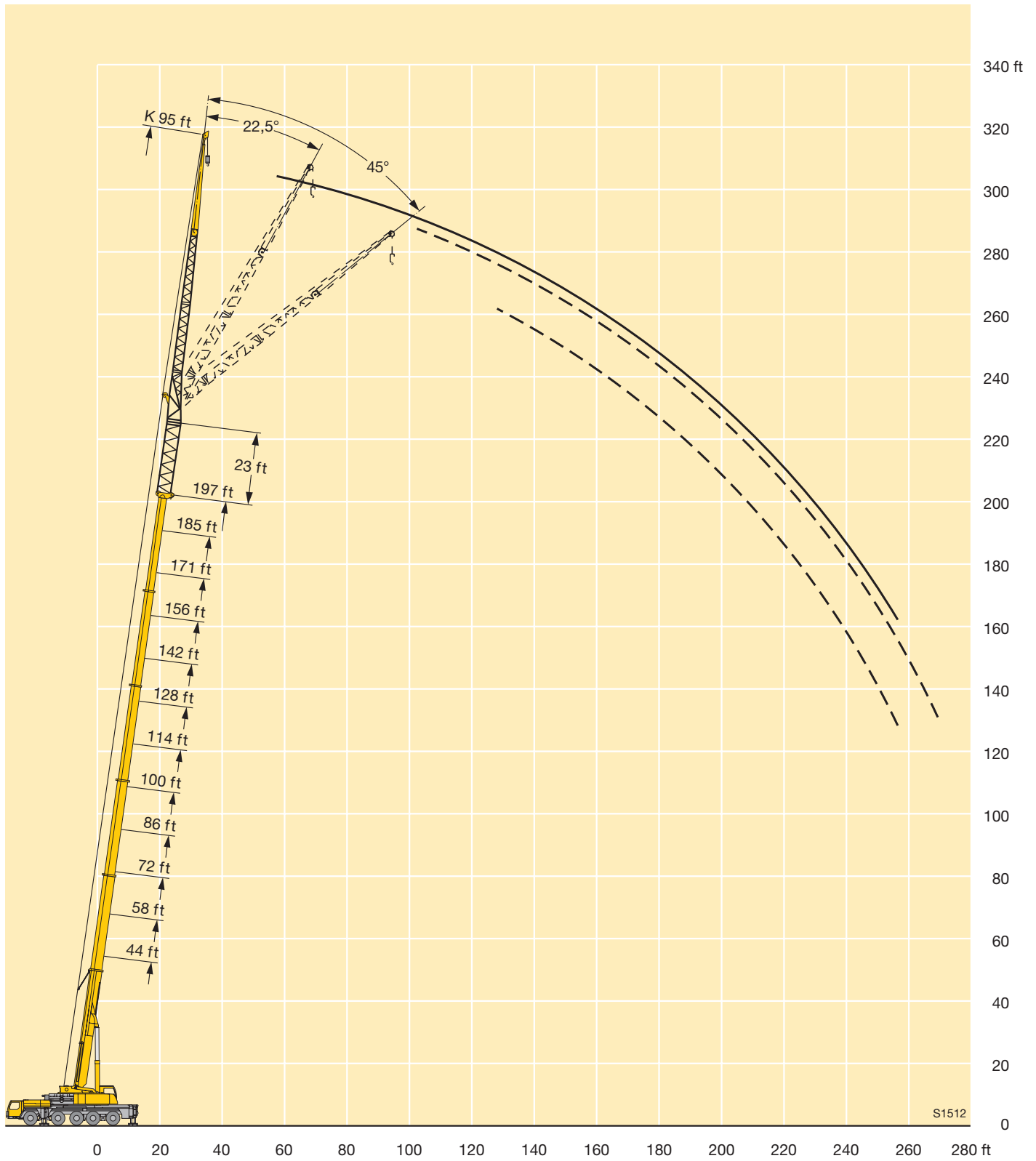

# Lifting capacities on the folding jib with boom extension

## Forces de levage à la fléchette pliante avec télescope rallongé



ft	44 ft + 23 ft			58 ft + 23 ft			72 ft + 23 ft			86 ft + 23 ft			100 ft + 23 ft			114 ft + 23 ft			ft
	118 ft			118 ft			118 ft			118 ft			118 ft			118 ft			
	0°	22,5°	45°	0°	22,5°	45°	0°	22,5°	45°	0°	22,5°	45°	0°	22,5°	45°	0°	22,5°	45°	
21	12.6																		21
24	12.6			11.9															24
27	12.6			11.9			10.9												27
30	12.6			11.9			10.9			10.4									30
33	12.6			11.9			10.9			10.4									33
36	12.6			11.9			10.9			10.4			9.7						36
39	12.6			11.9			10.9			10.4			9.7			9.2			39
45	12.3			11.8			10.9			10.4			9.7			9.2			45
51	11.9			11.5			10.8			10.4			9.7			9.2			51
57	11.4			11.1			10.6			10.3			9.7			9.2			57
63	10.8			10.7			10.3			10			9.5			9.2			63
69	10.3	8		10.2	8.1		9.9			9.7			9.3			9			69
75	9.7	7.8		9.7	7.9		9.5	7.3		9.4			9			8.8			75
81	9.2	7.4		9.3	7.4		9.1	7.2		9	7		8.7	6.8		8.5			81
87	8.6	7		8.8	7		8.7	6.9		8.6	6.9		8.4	6.8		8.3	6.3		87
93	8.1	6.6		8.3	6.7		8.3	6.6		8.3	6.6		8.1	6.5		8	6.3		93
99	7.7	6.3	4.8	7.9	6.3	4.8	7.9	6.3		7.9	6.3		7.8	6.2		7.7	6.1		99
105	7.2	5.9	4.8	7.5	6	4.8	7.5	6		7.6	6		7.5	6		7.4	5.9		105
111	6.8	5.6	4.7	7.1	5.7	4.7	7.1	5.8	4.6	7.3	5.8	4.6	7.2	5.7		7.2	5.7		111
117	6.3	5.3	4.5	6.7	5.5	4.5	6.8	5.5	4.4	6.9	5.5	4.5	6.9	5.5	4.4	6.9	5.5		117
123	6	5.1	4.4	6.3	5.2	4.4	6.5	5.2	4.4	6.6	5.3	4.4	6.6	5.3	4.3	6.6	5.3	4.3	123
129	5.6	4.9	4.3	6	5	4.3	6.2	5.1	4.3	6.3	5.1	4.3	6.3	5.1	4.3	6.4	5.1	4.2	129
135	5.3	4.7	4.2	5.7	4.8	4.2	5.9	4.9	4.2	6	4.9	4.2	6.1	4.9	4.2	6.1	5	4.2	135
141	4.9	4.5	4.1	5.3	4.6	4.1	5.6	4.7	4.1	5.8	4.8	4.1	5.9	4.8	4.1	5.9	4.8	4.1	141
147	4.6	4.4	4	5	4.5	4	5.3	4.6	4	5.5	4.6	4	5.6	4.6	4	5.7	4.7	4	147
153	4.4	4.2	4	4.8	4.3	4	5.1	4.4	4	5.2	4.5	4	5.4	4.5	4	5.5	4.5	4	153
159	4.1	4.1	4	4.5	4.2	4	4.8	4.3	3.9	5	4.4	3.9	5.1	4.4	3.9	5.3	4.4	3.9	159
165	3.9	4		4.3	4.1	4	4.6	4.2	3.9	4.8	4.3	3.9	5	4.3	3.9	5.1	4.3	3.9	165
171	3.7			4.1	4		4.4	4.1	3.9	4.6	4.1	3.9	4.8	4.2	3.8	4.9	4.2	3.8	171
177	3.5			3.8	4		4.2	4	3.9	4.4	4.1	3.9	4.6	4.1	3.8	4.7	4.2	3.8	177
183				3.7	4		4	3.9	3.9	4.3	4	3.9	4.5	4	3.8	4.6	4.1	3.8	183
189				3.6			3.8	3.9		4.1	3.9	3.9	4.3	3.9	3.8	4.4	4	3.8	189
195							3.7	3.9		4	3.9	3.9	4.2	3.9	3.8	4.3	3.9	3.8	195
207										3.7	3.9		3.9	3.8		4.1	3.8	3.8	207
219													3.6	3.8		3.8	3.8		219
231																3.6	3.7		231

TAB 172291 / 172298 / 172305

# Lifting capacities on the folding jib with boom extension

## Forces de levage à la fléchette pliante avec télescope rallongé



ft	128 ft + 23 ft			142 ft + 23 ft			156 ft + 23 ft			171 ft + 23 ft			185 ft + 23 ft			197 ft + 23 ft	ft
	118 ft			118 ft			118 ft			118 ft			118 ft			118 ft	
	0°	22,5°	45°	0°	22,5°	45°	0°	22,5°	45°	0°	22,5°	45°	0°	22,5°	45°	0°	
45	8.5			8													45
51	8.5			8			7.5			6.8							51
57	8.5			8			7.5			6.8			6.1				57
63	8.5			8			7.5			6.8			6.1				63
69	8.5			8			7.5			6.8			6.1			4.9	69
75	8.3			8			7.5			6.8			6.1			4.9	75
81	8.1			7.9			7.4			6.8			6.1			4.9	81
87	7.9	6.3		7.7			7.3			6.8			6.1			4.9	87
93	7.7	6.3		7.5	5.8		7.2			6.8			6.1			4.9	93
99	7.5	6		7.3	5.8		7	5.6		6.6	5.1		6.1			4.9	99
105	7.2	5.8		7.1	5.6		6.9	5.6		6.5	5.1		6			4.9	105
111	7	5.6		6.9	5.5		6.7	5.4		6.4	5.1		6	4.9		4.9	111
117	6.8	5.4		6.7	5.4		6.5	5.3		6.3	5.1		5.9	4.9		4.9	117
123	6.5	5.2	4.1	6.5	5.2		6.3	5.1		6.1	5		5.8	4.9		4.9	123
129	6.3	5.1	4.1	6.3	5.1	4.1	6.1	5	3.9	6	4.9		5.7	4.8		4.9	129
135	6.1	4.9	4.1	6.1	4.9	4.1	6	4.9	3.9	5.8	4.8	3.6	5.5	4.7		4.9	135
141	5.9	4.8	4.1	5.9	4.8	4	5.8	4.7	3.9	5.7	4.7	3.6	5.4	4.6	3.6	4.9	141
147	5.7	4.7	4	5.7	4.7	3.9	5.6	4.6	3.9	5.5	4.6	3.6	5.3	4.5	3.6	4.9	147
153	5.5	4.5	3.9	5.5	4.5	3.9	5.4	4.5	3.9	5.3	4.5	3.6	5.1	4.4	3.6	4.8	153
159	5.3	4.4	3.9	5.3	4.4	3.9	5.3	4.4	3.8	5.2	4.4	3.6	5	4.3	3.6	4.8	159
165	5.1	4.3	3.8	5.1	4.3	3.8	5.1	4.3	3.8	5.1	4.3	3.6	4.9	4.2	3.6	4.7	165
171	5	4.3	3.8	5	4.3	3.8	4.9	4.2	3.7	4.9	4.2	3.6	4.8	4.1	3.6	4.6	171
177	4.8	4.1	3.8	4.9	4.2	3.7	4.8	4.1	3.7	4.8	4.1	3.6	4.7	4.1	3.6	4.5	177
183	4.6	4.1	3.7	4.7	4.1	3.7	4.7	4.1	3.7	4.6	4	3.6	4.6	4	3.4	4.4	183
189	4.5	4	3.7	4.6	4	3.7	4.6	4	3.6	4.5	3.9	3.6	4.5	3.9	3.4	4.3	189
195	4.4	3.9	3.7	4.4	3.9	3.7	4.5	3.9	3.6	4.4	3.9	3.6	4.4	3.8	3.4	4.2	195
207	4.2	3.8	3.7	4.2	3.8	3.7	4.2	3.8	3.6	4.2	3.8	3.6	4.2	3.7	3.4	4.1	207
219	3.9	3.7	3.7	4	3.7	3.7	4	3.7	3.6	4	3.7	3.6	4	3.6	3.4	3.8	219
231	3.7	3.7		3.8	3.7	3.7	3.8	3.6	3.6	3.9	3.6	3.6	3.8	3.5	3.4	3.5	231
243	3.5	3.6		3.6	3.6		3.7	3.6	3.6	3.7	3.5	3.6	3.7	3.5	3.4	3.2	243
255				3.5	3.6		3.4	3.5	3.6	3.5	3.5	3.6	3.5	3.4	3.4	2.9	255
267				3.3			3.1	3.3		3.4	3.4	3.6	2.9	3.4	3.4	2.5	267
279							2.8			3.1	3.2			3	3.2		279

TAB 172291 / 172298 / 172305

# Lifting heights Hauteurs de levage

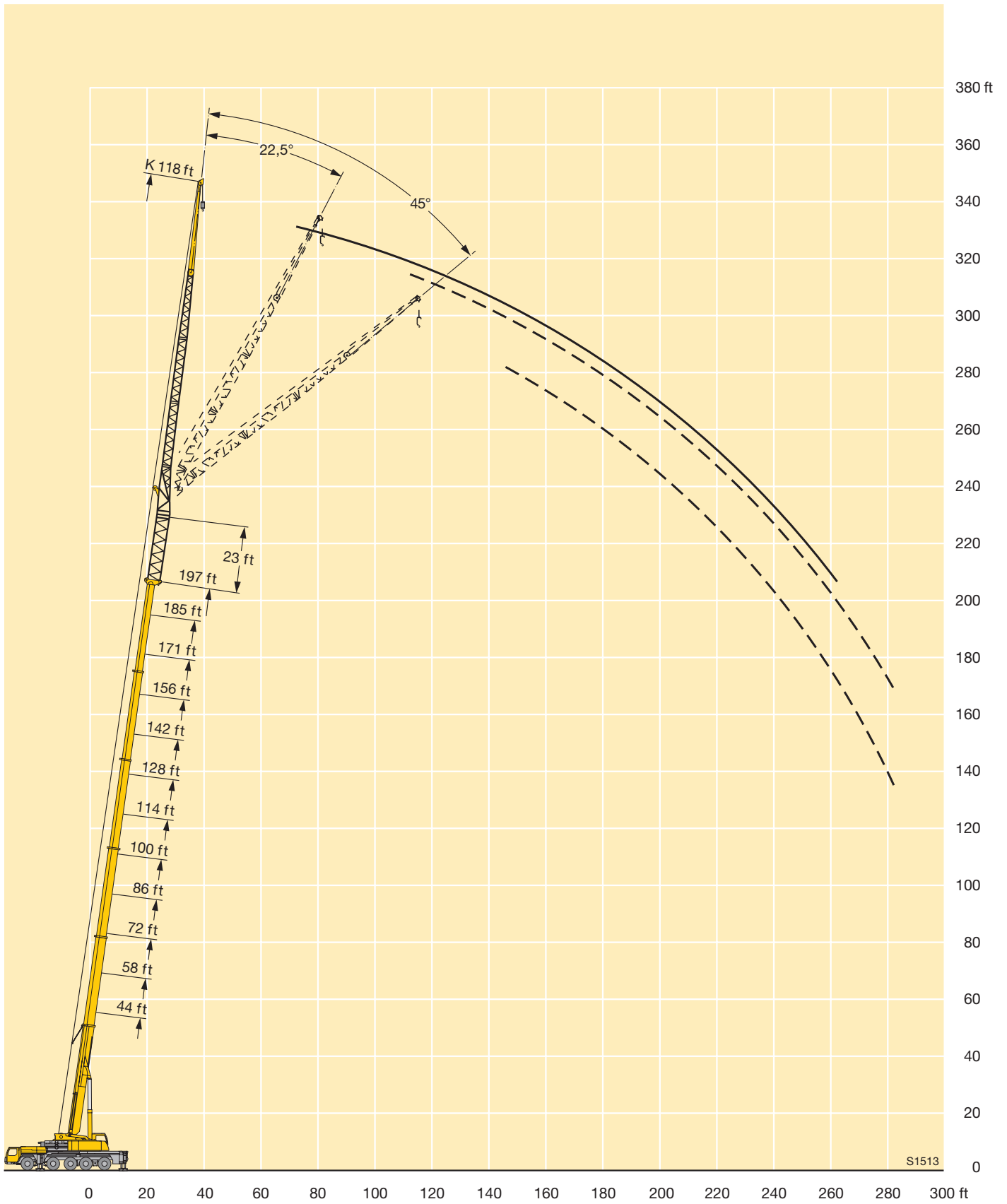

S1513

# Lifting capacities on the hydraulically variable folding jib with boom extension

## Capacités de levage à la fléchette pliante à variation hydraulique avec télescope rallongé



ft	44 ft + 23 ft			58 ft + 23 ft			72 ft + 23 ft			86 ft + 23 ft			100 ft + 23 ft			114 ft + 23 ft			ft
	40 ft			40 ft			40 ft			40 ft			40 ft			40 ft			
	0°	22,5°	45°	0°	22,5°	45°	0°	22,5°	45°	0°	22,5°	45°	0°	22,5°	45°	0°	22,5°	45°	
10	46.3																		10
12	46.3			46.3															12
14	46.3			46.3															14
16	46.3			46.3			46.3												16
18	46.3			46.3			46.3			46.3									18
21	46.3			46.3			46.3			46.3			41.6						21
24	46.3	41.8		46.3			46.3			46.2			41.5			38.2			24
27	46.3	41.3		46.3	40.2		46.3			45.6			41.2			38.1			27
30	46.1	39		46.2	39.9		46	37.5		44.3			40.7			37.9			30
33	45	37		45.6	38		44	37.4		42.9			39.7			37.6			33
36	42.1	35.2	25.7	43.5	36.3		42.1	35.9		41.5	35.3		38.8			36.9			36
39	39.8	33.6	25.7	41.3	34.8	25.7	40.3	34.5		39.9	34.1		37.8	32.7		36.2			39
45	35.6	30.9	25.7	37.3	32.1	25.7	37	32.1	25.7	37	32	25.7	35.6	31		34.6	30.1		45
51	32.1	28.6	24.8	34	29.9	25.2	33.7	29.9	25.4	34.5	30.1	25.6	33.2	29.3	25.6	32.8	28.9		51
57	29.1	26.5	23.8	31	27.8	24.4	30.9	27.7	24.6	32.1	28.2	25	30.8	27.8	25	30.9	27.5	24.4	57
63	26.4	24.6	23	28.6	26	23.5	28.2	25.6	23.7	29.8	26.5	24.2	28.3	26.3	24.1	28.9	26.3	23.8	63
69	24.2	22.7	22	26.4	24.2	22.8	25.8	23.8	22.7	27.6	24.7	23.2	26.1	24.7	23.1	26.9	25	23	69
75	22.3	21	21	24.4	22.6	21.9	23.8	22.1	21.5	25.6	23.2	22.1	24.2	23.1	22.1	25.1	23.7	22.1	75
81	20.4	19.5	19.9	22.7	21.2	21	22	20.7	20.3	23.8	21.8	21	22.4	21.6	21.1	23.4	22.3	21.3	81
87	18.8	18.2	18.5	21.1	19.9	20	20.3	19.4	19.2	22.3	20.6	20	20.8	20.2	20	22	20.9	20.3	87
93	17.3			19.7	18.7	19	19	18.2	18.2	20.8	19.5	19.1	19.5	18.9	18.9	20.6	19.8	19.4	93
99				18.4	17.7		17.7	17.2	17.3	19.5	18.5	18.2	18.3	17.8	17.8	19.4	18.7	18.4	99
105				17.1	16.7		16.5	16.2	16.4	18.4	17.6	17.4	17	16.8	16.8	18.3	17.6	17.5	105
111				16.1	16.1		15.5	15.3	15.6	17.3	16.8	16.8	16.1	15.8	15.9	17.3	16.8	16.6	111
117							14.6	14.5		16.4	16	16.1	15.2	14.9	15	16.3	15.9	15.9	117
123							13.8	13.8		15.6	15.3		14.3	14.1	14.3	15.5	15.1	15.1	123
129										14.8	14.6		13.5	13.4	13.5	14.7	14.4	14.5	129
135										14.1	14.1		12.8	12.7		14	13.8	13.8	135
141													12.2	12.1		13.3	13.1	13.3	141
147													11.5	11.6		12.7	12.6		147
153																12.2	12.1		153
159																11.6	11.6		159

TAB 172333 / 172340 / 172347

# Lifting capacities on the hydraulically variable folding jib with boom extension

## Capacités de levage à la fléchette pliante à variation hydraulique avec télescope rallongé



ft	128 ft + 23 ft			142 ft + 23 ft			156 ft + 23 ft			171 ft + 23 ft			185 ft + 23 ft			197 ft + 23 ft			ft
	40 ft			40 ft			40 ft			40 ft			40 ft			40 ft			
	0°	22,5°	45°	0°	22,5°	45°	0°	22,5°	45°	0°	22,5°	45°	0°	22,5°	45°	0°	22,5°	45°	
27	34.2																		27
30	34.2			31.7															30
33	34			31.7															33
36	33.8			31.6			27.7												36
39	33.4			31.4			27.7			25.5									39
45	32.4			30.8			27.7			25.5			21.3				18.7		45
51	31.1	27.5		30.1	26.9		27.7			25.5			21.3				18.7		51
57	29.7	26.7	23.5	29.1	26.1		27.3	24		25.3	22.6		21.3				18.7		57
63	28.3	25.6	23.1	27.8	25.2	22.4	26.6	23.5	21.1	25.1	22.4		21.3	20.6			18.7		63
69	26.7	24.5	22.4	26.6	24.2	22	25.6	22.8	21	24.7	22	19.4	21.2	20.5	18.2	18.7	18.7		69
75	25.1	23.4	21.7	25.2	23.3	21.4	24.6	22.1	20.5	23.8	21.4	19.3	20.8	20.3	18	18.6	18.5	15.8	75
81	23.5	22.3	21	23.9	22.3	20.8	23.5	21.3	19.9	23	20.8	18.9	20.2	20	17.6	18.3	18.1	15.7	81
87	22	21.1	20.2	22.5	21.3	20.1	22.4	20.5	19.2	22.2	20.1	18.4	19.8	19.5	17.3	17.8	17.6	15.5	87
93	20.7	20	19.3	21.2	20.3	19.3	21.3	19.7	18.6	21.3	19.5	17.8	19.3	18.9	16.9	17.3	17	15.3	93
99	19.4	18.9	18.4	20.1	19.3	18.6	20.1	18.9	18	20.3	18.8	17.3	18.7	18.3	16.4	16.8	16.4	15.1	99
105	18.1	17.9	17.7	19	18.4	17.8	19.2	18.1	17.5	19.3	18.1	16.8	18.1	17.7	16	16.2	15.8	14.8	105
111	17.2	17	16.9	17.9	17.5	17.1	18.2	17.4	16.9	18.4	17.4	16.4	17.5	17.1	15.6	15.6	15.2	14.4	111
117	16.2	16.1	16.1	17	16.7	16.4	17.3	16.6	16.4	17.6	16.7	15.9	16.9	16.5	15.2	15	14.7	14.1	117
123	15.3	15.2	15.3	16.1	15.9	15.8	16.4	15.9	15.8	16.8	16.1	15.5	16.3	15.9	14.8	14.4	14.1	13.7	123
129	14.4	14.4	14.6	15.3	15.1	15.1	15.6	15.3	15.2	16	15.5	15	15.7	15.3	14.5	13.8	13.6	13.3	129
135	13.6	13.6	13.8	14.5	14.4	14.4	14.8	14.6	14.6	15.3	14.8	14.6	15.1	14.8	14.1	13.2	13	13	135
141	12.9	12.9	13.1	13.8	13.7	13.8	14	13.9	14	14.6	14.2	14.1	14.4	14.3	13.8	12.6	12.5	12.6	141
147	12.2	12.3	12.4	13.1	13.1	13.2	13.2	13.3	13.4	13.9	13.6	13.7	13.9	13.7	13.5	12	12	12.1	147
153	11.5	11.6	11.8	12.5	12.5	12.6	12.5	12.6	12.8	13.2	13.1	13.2	13.3	13.2	13.1	11.4	11.5	11.7	153
159	11	11		11.9	11.9	12	11.9	12	12.2	12.5	12.5	12.6	12.7	12.7	12.8	10.9	11	11.2	159
165	10.4	10.5		11.3	11.4	11.5	11.3	11.4	11.6	11.9	12	12.1	12.2	12.2	12.3	10.4	10.5	10.7	165
171	9.9	10		10.9	10.8		10.7	10.9	11	11.4	11.4	11.6	11.7	11.7	11.8	9.9	10.1	10.2	171
177	9.4	9.5		10.4	10.4		10.1	10.3	10.4	10.9	11	11.1	11.1	11.2	11.4	9.4	9.6	9.8	177
183	6.6			9.9	10		9.5	9.7	9.8	10.3	10.5	10.6	10.7	10.8	10.9	9	9.2	9.3	183
189				9.5	9.6		9	9.2		9.8	10	10.1	9.8	10.3	10.5	8.5	8.7	8.8	189
195				7			8.6	8.7		9.4	9.5	9.6	8.9	9.5	9.7	8.1	8.3	8.4	195
207										8.5	8.7		7.3	7.8	7.9	7.1	7.5	7.6	207
219													6	6.3		5.7	6.1	6.2	219
231																4.4	4.8		231

TAB 172333 / 172340 / 172347

# Lifting capacities on the hydraulically variable folding jib with boom extension

## Capacités de levage à la fléchette pliante à variation hydraulique avec télescope rallongé



ft	44 ft + 23 ft			58 ft + 23 ft			72 ft + 23 ft			86 ft + 23 ft			100 ft + 23 ft			114 ft + 23 ft			ft
	63 ft			63 ft			63 ft			63 ft			63 ft			63 ft			
	0°	22,5°	45°	0°	22,5°	45°	0°	22,5°	45°	0°	22,5°	45°	0°	22,5°	45°	0°	22,5°	45°	
14	41																		14
16	41																		16
18	40.6			37.1															18
21	40			36.9			32.7			30.3									21
24	39.4			36.5			32.7			30.2									24
27	38.2			36			32.4			30.1			27.2			24			27
30	36.4			35.3			31.9			30			27.1			24			30
33	34.6			34.1			31.5			29.6			27			23.8			33
36	33			32.7			30.9			29.2			26.8			23.8			36
39	31.5	26		31.4			30			28.8			26.4			23.8			39
45	28.6	24.3		29	24.6		28	23.7		27.4			25.8			23.5			45
51	26	22.6		26.7	23.2		26.2	22.5		25.9	21.6		24.6	20.9		23.1			51
57	23.7	21	17.9	24.6	21.6	17.9	24.5	21.1		24.4	20.8		23.5	20.2		22.4	19.5		57
63	21.7	19.4	17.5	22.7	20.2	17.5	22.8	19.9	16.7	23	19.8	17	22.3	19.3		21.6	18.8		63
69	19.8	17.9	16.8	20.9	18.9	16.9	21.3	18.9	16.6	21.6	18.8	16.7	21.2	18.4	16.2	20.8	18.1		69
75	18.1	16.6	16	19.3	17.8	16.3	19.8	17.9	16.2	20.3	17.9	16.2	20	17.6	15.9	19.9	17.4	15.3	75
81	16.6	15.4	15.2	18	16.8	15.6	18.5	16.9	15.5	19.1	17.1	15.6	18.9	16.8	15.3	19	16.8	15.1	81
87	15.4	14.3	14.4	16.6	15.8	14.8	17.3	16	14.9	17.9	16.3	15	17.9	16.1	14.8	18.2	16.1	14.7	87
93	14.2	13.4	13.6	15.5	14.9	14.1	16.1	15.1	14.2	16.8	15.5	14.4	16.9	15.4	14.3	17.3	15.5	14.2	93
99	13.1	12.6	12.8	14.5	14	13.4	15	14.3	13.6	15.9	14.8	13.8	15.9	14.8	13.8	16.5	14.9	13.7	99
105	12.2	11.8	12.2	13.5	13.2	12.8	14.1	13.5	13	15.1	14.1	13.3	15	14.2	13.3	15.6	14.3	13.3	105
111	11.4	11.1	11.7	12.6	12.5	12.3	13.3	12.8	12.4	14.2	13.5	12.8	14.1	13.6	12.9	14.8	13.8	12.9	111
117	10.6	10.5		11.9	11.9	11.9	12.5	12.2	11.9	13.5	12.9	12.4	13.2	13	12.5	14.1	13.3	12.6	117
123				11.2	11.3		11.8	11.5	11.4	12.9	12.3	12	12.4	12.3	12.1	13.4	12.8	12.2	123
129				10.5	10.8		11.2	11	11	12.2	11.8	11.6	11.7	11.7	11.6	12.7	12.2	11.9	129
135							10.6	10.5		11.6	11.3	11.2	11.1	11.1	11.1	12	11.7	11.5	135
141							10	10		11.1	10.8	10.9	10.5	10.5	10.6	11.4	11.1	11.1	141
147										10.6	10.4		9.9	10	10.1	10.9	10.7	10.7	147
153										10.1	10.1		9.4	9.5		10.4	10.2	10.3	153
159										9.8			8.9	9		9.8	9.7	9.9	159
165													8.5	8.6		9.4	9.3		165
171													8.1			9	8.9		171
177													7.8			8.6	8.6		177
183																8.2	8.2		183
189																8			189

TAB 172333 / 172340 / 172347

# Lifting capacities on the hydraulically variable folding jib with boom extension

## Capacités de levage à la fléchette pliante à variation hydraulique avec télescope rallongé



ft	128 ft + 23 ft			142 ft + 23 ft			156 ft + 23 ft			171 ft + 23 ft			185 ft + 23 ft			197 ft + 23 ft			ft
	63 ft			63 ft			63 ft			63 ft			63 ft			63 ft			
	0°	22,5°	45°	0°	22,5°	45°	0°	22,5°	45°	0°	22,5°	45°	0°	22,5°	45°	0°	22,5°	45°	
30	21.6																		30
33	21.6																		33
36	21.6			20.1															36
39	21.6			20.1			18.4												39
45	21.6			20.1			18.4		17				15.5						45
51	21.4			20.1			18.4		17				15.5			13.6			51
57	21			20			18.4		17				15.5			13.6			57
63	20.4	18		19.6	17.5		18.4		17				15.5			13.6			63
69	19.8	17.6		19.1	17.1		18.2	16.3	16.8	15.3			15.4			13.6			69
75	19.2	16.9	14.8	18.6	16.5		17.8	16.1	16.6	15.2			15.3	14.1		13.6			75
81	18.5	16.3	14.6	18.1	16.1	14.1	17.3	15.6	13.6	16.4	15		15.2	14		13.6	12.6		81
87	17.8	15.8	14.2	17.5	15.6	14	16.9	15.1	13.5	16.1	14.7	12.9	15	13.8		13.4	12.6		87
93	17.2	15.2	13.8	16.9	15	13.8	16.4	14.7	13.3	15.8	14.3	12.8	14.7	13.6	12.1	13.3	12.3	10.9	93
99	16.5	14.7	13.6	16.3	14.5	13.4	15.9	14.2	13.2	15.3	13.9	12.6	14.5	13.4	12.1	13.1	12.1	10.9	99
105	15.7	14.2	13.2	15.7	14.1	13.1	15.3	13.8	12.8	14.9	13.5	12.4	14.2	13	11.9	12.9	12.1	10.9	105
111	15	13.6	12.8	15.1	13.6	12.7	14.9	13.4	12.5	14.5	13.1	12.3	13.9	12.7	11.9	12.6	11.9	10.9	111
117	14.3	13.2	12.5	14.5	13.2	12.4	14.3	13	12.2	14.1	12.8	12.1	13.5	12.4	11.7	12.2	11.7	10.7	117
123	13.6	12.8	12.2	13.9	12.8	12.1	13.8	12.7	12	13.6	12.5	11.8	13.2	12.1	11.5	11.8	11.4	10.5	123
129	12.9	12.3	11.9	13.3	12.4	11.9	13.3	12.3	11.7	13.2	12.1	11.6	12.8	11.8	11.3	11.5	11.2	10.4	129
135	12.2	11.9	11.6	12.7	12	11.6	12.7	11.9	11.5	12.7	11.8	11.4	12.5	11.5	11.1	11.1	10.8	10.2	135
141	11.5	11.4	11.3	12.1	11.6	11.3	12.2	11.6	11.3	12.3	11.5	11.2	12.1	11.3	10.9	10.7	10.5	10	141
147	10.9	10.9	10.9	11.5	11.2	11.1	11.7	11.2	11	11.8	11.2	10.9	11.7	11	10.7	10.3	10.1	9.8	147
153	10.3	10.4	10.5	10.9	10.8	10.8	11.2	10.9	10.8	11.4	10.9	10.7	11.3	10.8	10.5	9.9	9.8	9.6	153
159	9.8	9.9	10.1	10.4	10.3	10.4	10.6	10.5	10.5	10.9	10.6	10.5	10.9	10.5	10.3	9.5	9.4	9.4	159
165	9.3	9.4	9.6	9.9	9.9	10	10.1	10.1	10.2	10.4	10.3	10.3	10.5	10.2	10.1	9.1	9.1	9.2	165
171	8.8	8.9	9.1	9.5	9.5	9.7	9.6	9.7	9.8	10	9.9	10	10.1	9.9	9.8	8.7	8.8	8.9	171
177	8.3	8.5	8.6	9	9.1	9.2	9.2	9.3	9.5	9.6	9.6	9.7	9.7	9.6	9.6	8.3	8.4	8.6	177
183	7.9	8		8.6	8.7	8.8	8.7	8.9	9.1	9.1	9.2	9.4	9.3	9.3	9.4	7.9	8.1	8.3	183
189	7.5	7.6		8.2	8.3	8.4	8.3	8.4	8.6	8.7	8.9	9.1	8.9	9	9.1	7.5	7.7	8	189
195	7.1	7.2		7.8	7.9		7.8	8	8.2	8.4	8.5	8.7	8.6	8.6	8.8	7.1	7.4	7.6	195
207				7.2	7.2		7	7.2	7.2	7.5	7.7	7.9	7.6	8	8.2	6.4	6.6	6.9	207
219							6.2	6.4		6.9	7	7.1	6.2	7	7.2	5.7	6	6.1	219
231										6.2	6.3		5.1	5.6		4.8	5.3	5.4	231
243													3.9	4.4		3.6	4.2		243
255																2.5	3		255

TAB 172333 / 172340 / 172347

# Lifting capacities on the hydraulically variable folding jib with boom extension

## Capacités de levage à la fléchette pliante à variation hydraulique avec télescope rallongé



ft	44 ft + 23 ft			58 ft + 23 ft			72 ft + 23 ft			86 ft + 23 ft			100 ft + 23 ft			114 ft + 23 ft			ft
	72 ft			72 ft			72 ft			72 ft			72 ft			72 ft			
	0°	22,5°	45°	0°	22,5°	45°	0°	22,5°	45°	0°	22,5°	45°	0°	22,5°	45°	0°	22,5°	45°	
14	23.3																		14
16	23.3																		16
18	23.3			22.1			20.6												18
21	23.3			22.1			20.6			19.6									21
24	23.2			22.1			20.6			19.6			18.4						24
27	23			22.1			20.6			19.6			18.4			17.7			27
30	22.7			22			20.6			19.6			18.4			17.7			30
33	22.4			21.8			20.6			19.6			18.4			17.7			33
36	22			21.5			20.6			19.6			18.4			17.7			36
39	21.7			21.2			20.4			19.6			18.4			17.7			39
45	20.8	18.1		20.6	18		19.9			19.4			18.2			17.6			45
51	20	17.4		19.9	17.4		19.3	16.8		19			18			17.4			51
57	19.2	16.6		19.2	16.6		18.8	16.4		18.5	16.1		17.7	15.7		17.2			57
63	18.3	15.9	13.1	18.5	15.9	13.1	18.2	15.8		18	15.7		17.3	15.4		16.9	15		63
69	17.5	15.2	12.8	17.8	15.3	12.8	17.6	15.2	12.6	17.5	15.2		16.9	15		16.5	14.8		69
75	16.5	14.5	12.5	17.1	14.7	12.5	17	14.7	12.4	16.9	14.7	12.3	16.4	14.5	12.2	16.1	14.4		75
81	15.6	13.9	12.2	16.2	14.2	12.2	16.4	14.2	12.1	16.4	14.3	12.2	16	14.1	12.1	15.7	14	11.9	81
87	14.7	13.4	11.9	15.4	13.7	12	15.7	13.8	12	15.8	13.9	11.9	15.5	13.8	11.9	15.3	13.7	11.8	87
93	13.8	12.8	11.7	14.6	13.2	11.8	14.9	13.3	11.8	15.1	13.5	11.8	14.9	13.4	11.7	14.9	13.4	11.6	93
99	12.8	12.2	11.5	13.7	12.7	11.6	14.2	12.8	11.6	14.5	13	11.6	14.4	13	11.5	14.4	13	11.5	99
105	11.9	11.5	11.2	12.9	12.1	11.4	13.4	12.4	11.4	13.9	12.6	11.5	13.8	12.6	11.4	13.9	12.6	11.4	105
111	11.2	10.8	10.8	12.2	11.5	11.1	12.7	11.9	11.3	13.2	12.1	11.3	13.2	12.2	11.3	13.4	12.2	11.2	111
117	10.5	10.3	10.4	11.5	11	10.8	12.1	11.3	11	12.6	11.7	11.1	12.7	11.7	11.2	12.9	11.8	11.1	117
123	9.8	9.7		10.8	10.4	10.5	11.4	10.8	10.6	12	11.2	10.8	12	11.3	10.9	12.4	11.4	10.9	123
129	9.2			10.2	10	10.2	10.8	10.4	10.3	11.5	10.8	10.6	11.4	10.9	10.6	11.9	11.1	10.6	129
135				9.7	9.6		10.3	9.9	10	11	10.4	10.3	10.9	10.5	10.3	11.4	10.7	10.4	135
141				9.2			9.8	9.5		10.5	10	10	10.3	10.1	10.1	10.9	10.4	10.1	141
147							9.3	9.1		10.1	9.7	9.8	9.8	9.7	9.8	10.4	10.1	10	147
153							8.8			9.7	9.4		9.3	9.2	9.4	10	9.7	9.7	153
159										9.3	9.1		8.8	8.8	8.9	9.5	9.4	9.5	159
165										8.9			8.4	8.4		9.1	9	9.1	165
171													7.9	8		8.7	8.6	8.8	171
177													7.5	7.6		8.3	8.3	8.5	177
183													7.2	7.3		7.9	8		183
189																7.6	7.6		189
195																7.3	7.5		195

TAB 172333 / 172340 / 172347

# Lifting capacities on the hydraulically variable folding jib with boom extension

## Capacités de levage à la fléchette pliante à variation hydraulique avec télescope rallongé



ft	128 ft + 23 ft			142 ft + 23 ft			156 ft + 23 ft			171 ft + 23 ft			185 ft + 23 ft			197 ft + 23 ft			ft
	72 ft			72 ft			72 ft			72 ft			72 ft			72 ft			
	0°	22,5°	45°	0°	22,5°	45°	0°	22,5°	45°	0°	22,5°	45°	0°	22,5°	45°	0°	22,5°	45°	
30	16.3																		30
33	16.3																		33
36	16.3			15.8															36
39	16.3			15.8			14.8												39
45	16.3			15.8			14.8			13.6									45
51	16.3			15.6			14.8			13.6			12.6			11.2			51
57	16.2			15.5			14.8			13.6			12.6			11.2			57
63	16	14.6		15.4			14.7			13.6			12.6			11.2			63
69	15.8	14.5		15.2	14		14.5			13.6			12.6			11.2			69
75	15.5	14.1		15	13.9		14.3	13.1		13.5	12.6		12.6			11.2			75
81	15.1	13.8	11.6	14.7	13.6		14.1	13.1		13.4	12.6		12.6	11.9		11.2			81
87	14.8	13.5	11.6	14.4	13.3	11.4	13.9	13		13.3	12.6		12.4	11.9		11.2	10.7		87
93	14.4	13.2	11.6	14.1	13	11.4	13.6	12.8	11.2	13.1	12.3	10.9	12.3	11.9		11.2	10.7		93
99	14.1	12.9	11.4	13.8	12.7	11.3	13.3	12.5	11.2	12.9	12.2	10.9	12.2	11.7	10.4	11.1	10.7		99
105	13.7	12.5	11.3	13.5	12.4	11.2	13.1	12.2	11.1	12.6	11.9	10.9	12	11.4	10.4	11	10.7		105
111	13.2	12.1	11.2	13.2	12	11.1	12.8	11.8	10.9	12.4	11.6	10.8	11.8	11.2	10.4	10.9	10.5	9.7	111
117	12.8	11.7	11	12.8	11.7	11	12.5	11.5	10.8	12.1	11.3	10.6	11.6	10.9	10.4	10.8	10.3	9.7	117
123	12.4	11.4	10.8	12.4	11.3	10.8	12.2	11.2	10.6	11.9	11	10.4	11.4	10.7	10.2	10.6	10.1	9.6	123
129	12	11	10.6	12	11	10.5	11.8	10.9	10.4	11.6	10.8	10.2	11.2	10.4	10	10.3	9.9	9.5	129
135	11.5	10.7	10.4	11.6	10.7	10.3	11.5	10.6	10.2	11.3	10.5	10.1	11	10.2	9.8	10.1	9.7	9.4	135
141	11	10.4	10.1	11.2	10.4	10.1	11.2	10.3	10	11.1	10.2	9.9	10.7	10	9.7	9.9	9.5	9.3	141
147	10.5	10.1	9.9	10.8	10.2	9.9	10.8	10.1	9.8	10.8	10	9.7	10.5	9.8	9.5	9.7	9.3	9.1	147
153	10	9.8	9.7	10.4	9.9	9.8	10.5	9.9	9.7	10.5	9.8	9.6	10.3	9.6	9.4	9.4	9.1	9	153
159	9.6	9.5	9.5	10	9.6	9.6	10.1	9.6	9.5	10.2	9.6	9.4	10	9.4	9.3	9	8.9	8.8	159
165	9.1	9.1	9.3	9.6	9.3	9.4	9.7	9.4	9.4	9.8	9.4	9.3	9.8	9.2	9.1	8.7	8.7	8.7	165
171	8.6	8.8	8.9	9.2	9	9.2	9.3	9.1	9.2	9.5	9.1	9.2	9.5	9	9	8.4	8.4	8.5	171
177	8.2	8.3	8.5	8.8	8.8	9	8.9	8.8	9	9.2	8.9	9	9.2	8.8	8.9	8	8.1	8.3	177
183	7.8	7.9	8.1	8.4	8.4	8.6	8.5	8.6	8.7	8.8	8.7	8.8	8.9	8.7	8.8	7.7	7.8	8	183
189	7.4	7.5		8	8.1	8.3	8.1	8.3	8.5	8.5	8.4	8.6	8.6	8.5	8.7	7.3	7.5	7.7	189
195	7	7.2		7.6	7.7	7.9	7.7	7.9	8.1	8.1	8.2	8.4	8.3	8.2	8.5	7	7.2	7.5	195
207	6.3	6.4		7	7.1		6.9	7.2	7.3	7.4	7.6	7.8	7.6	7.7	8	6.3	6.6	6.8	207
219				6.4			6.2	6.4		6.7	6.9	7.1	6.6	7.2	7.4	5.7	5.9	6.1	219
231							5.5			6.1	6.3		5.4	6.1	6.3	5	5.3	5.5	231
243										5.5			4.3	5		4	4.7	4.8	243
255													3.3	3.7		2.9	3.5		255
267																2.4			267

TAB 172333 / 172340 / 172347

# Lifting heights Hauteurs de levage

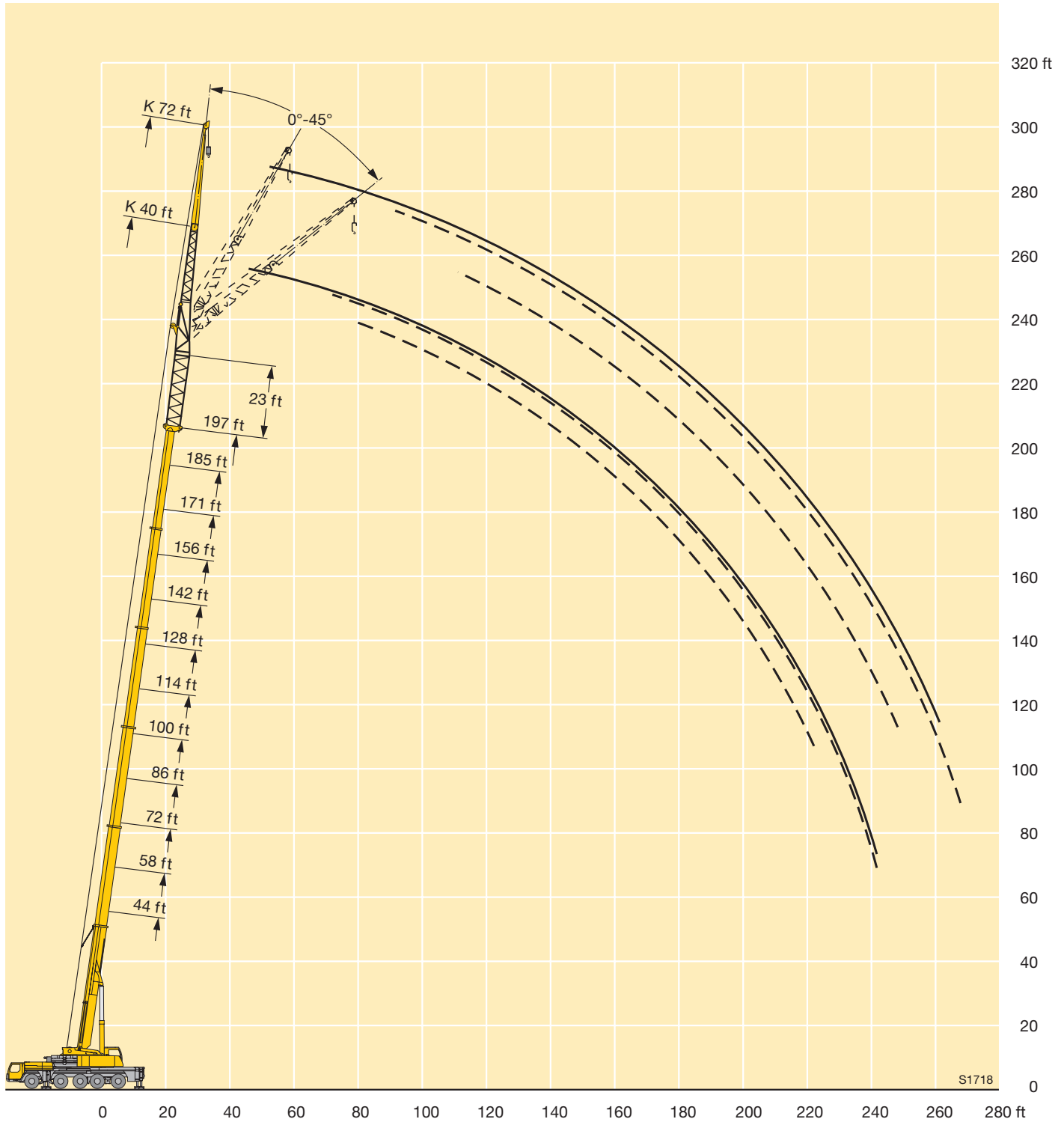

# Lifting capacities on the hydraulically variable folding jib with boom extension

## Capacités de levage à la fléchette pliante à variation hydraulique avec télescope rallongé



ft	44 ft + 23 ft			58 ft + 23 ft			72 ft + 23 ft			86 ft + 23 ft			100 ft + 23 ft			114 ft + 23 ft			ft
	86 ft			86 ft			86 ft			86 ft			86 ft			86 ft			
	0°	22,5°	45°	0°	22,5°	45°	0°	22,5°	45°	0°	22,5°	45°	0°	22,5°	45°	0°	22,5°	45°	
18	26																		18
21	26			23															21
24	25.9			23			20.6			19.4									24
27	25.6			23			20.6			19.4			17.5						27
30	25.2			23			20.6			19.4			17.5			16.5			30
33	24.6			22.8			20.6			19.4			17.5			16.5			33
36	23.9			22.6			20.6			19.3			17.5			16.5			36
39	23.1			22.3			20.4			19.2			17.5			16.5			39
45	21.6			21.5			19.9			19			17.4			16.5			45
51	20	15.9		20.5			19.3			18.5			17.2			16.3			51
57	18.5	15.1		19.3	14.6		18.5	14.3		18			16.8			16			57
63	17.2	14.2		18.2	14.1		17.6	13.9		17.3	13.5		16.4			15.7			63
69	15.9	13.3		17	13.4		16.7	13.2		16.5	13.2		15.9	12.6		15.3	12.1		69
75	14.8	12.6	9.7	15.9	12.7	9.7	15.8	12.6		15.7	12.6		15.2	12.4		14.9	11.9		75
81	13.7	11.9	9.6	14.9	12.1	9.6	14.9	12	9.2	14.9	12	9.2	14.5	11.9		14.3	11.6		81
87	12.7	11.2	9.2	13.8	11.5	9.3	14	11.5	9.2	14.2	11.6	9.2	13.9	11.4	8.9	13.7	11.4		87
93	11.7	10.7	8.9	13	10.9	9	13.1	11	9	13.4	11.1	8.9	13.2	11	8.9	13.2	11	8.6	93
99	10.8	10.1	8.6	12.1	10.5	8.7	12.4	10.6	8.7	12.7	10.7	8.7	12.6	10.6	8.7	12.6	10.6	8.6	99
105	10.1	9.7	8.4	11.2	10	8.5	11.7	10.2	8.5	12	10.3	8.5	12	10.3	8.5	12.1	10.3	8.4	105
111	9.4	9.2	8.2	10.6	9.5	8.3	11	9.8	8.3	11.4	9.9	8.4	11.4	10	8.3	11.5	10	8.3	111
117	8.7	8.7	8.1	10	9.1	8.2	10.3	9.4	8.2	10.8	9.6	8.2	10.9	9.6	8.2	11	9.7	8.2	117
123	8.2	8.2	8	9.3	8.7	8.1	9.8	9	8.1	10.3	9.2	8.1	10.4	9.3	8.1	10.5	9.4	8.1	123
129	7.6	7.7	7.8	8.7	8.3	7.9	9.3	8.6	8	9.7	8.8	8	9.9	8.9	8	10.1	9	8	129
135	7.1	7.3		8.2	7.9	7.8	8.8	8.2	7.9	9.2	8.5	7.9	9.5	8.6	7.9	9.7	8.7	7.9	135
141	6.6			7.7	7.5	7.6	8.3	7.8	7.7	8.8	8.1	7.8	9	8.3	7.8	9.3	8.4	7.8	141
147				7.3	7.1		7.9	7.5	7.5	8.4	7.8	7.6	8.6	8	7.7	8.9	8.1	7.7	147
153				6.8			7.5	7.2		8	7.5	7.5	8.1	7.7	7.5	8.5	7.9	7.6	153
159							7.1	6.9		7.6	7.2	7.4	7.7	7.4	7.3	8.2	7.6	7.4	159
165							6.7			7.3	7		7.3	7.1	7.2	7.8	7.3	7.3	165
171										7	6.8		6.9	6.8	7	7.5	7.1	7.1	171
177										6.6	6.6		6.6	6.6	6.7	7.1	6.9	7	177
183										6.4			6.2	6.3		6.8	6.7	6.9	183
189													5.9	5.9		6.5	6.4	6.6	189
195													5.6	5.7		6.2	6.2		195
207																5.6	5.8		207

TAB 172333 / 172340 / 172347

# Lifting capacities on the hydraulically variable folding jib with boom extension

## Capacités de levage à la fléchette pliante à variation hydraulique avec télescope rallongé



ft	128 ft + 23 ft			142 ft + 23 ft			156 ft + 23 ft			171 ft + 23 ft			185 ft + 23 ft			197 ft + 23 ft			ft
	86 ft			86 ft			86 ft			86 ft			86 ft			86 ft			
	0°	22,5°	45°	0°	22,5°	45°	0°	22,5°	45°	0°	22,5°	45°	0°	22,5°	45°	0°	22,5°	45°	
39	15																		39
45	15			14.3			13.1												45
51	15			14.3			13.1			11.9			10.9						51
57	15			14.2			13.1			11.9			10.9			9.5			57
63	14.7			14			13.1			11.9			10.9			9.5			63
69	14.4			13.7			13			11.9			10.9			9.5			69
75	14.1	11.4		13.5	11.5		12.8			11.9			10.9			9.5			75
81	13.7	11.3		13.2	11.4		12.5	10.4		11.8	10.2		10.9			9.4			81
87	13.2	11.2		12.8	11		12.2	10.4		11.6	10.2		10.7	9.5		9.2			87
93	12.8	10.8	8.5	12.5	10.7		11.9	10.4		11.4	10.2		10.6	9.5		9.2	8.5		93
99	12.3	10.5	8.5	12.1	10.4	8.3	11.6	10.2	8	11.2	9.9		10.4	9.5		9	8.5		99
105	11.8	10.2	8.3	11.7	10.1	8.3	11.3	9.9	8	10.9	9.7		10.2	9.4		9	8.5		105
111	11.4	9.9	8.2	11.2	9.9	8.2	11	9.7	8	10.6	9.5	7.8	10.1	9.2		9	8.3		111
117	10.9	9.6	8.1	10.9	9.6	8.1	10.6	9.4	8	10.3	9.2	7.8	9.8	8.9	7.5	9	8.3	7	117
123	10.5	9.3	8	10.5	9.3	8	10.3	9.1	7.9	10	9	7.7	9.6	8.7	7.5	8.8	8.1	7	123
129	10.1	9	7.9	10.1	9	7.9	10	8.8	7.8	9.7	8.7	7.7	9.3	8.4	7.5	8.6	7.9	7	129
135	9.7	8.7	7.8	9.8	8.7	7.8	9.6	8.6	7.7	9.4	8.5	7.6	9.1	8.2	7.5	8.4	7.8	7	135
141	9.3	8.4	7.7	9.4	8.4	7.7	9.3	8.3	7.6	9.1	8.2	7.5	8.8	8	7.4	8.2	7.6	7	141
147	9	8.1	7.6	9.1	8.2	7.6	9	8.1	7.5	8.9	8	7.4	8.6	7.8	7.3	8	7.4	6.9	147
153	8.7	7.9	7.5	8.8	7.9	7.5	8.7	7.9	7.4	8.6	7.8	7.3	8.4	7.6	7.2	7.8	7.2	6.8	153
159	8.3	7.6	7.4	8.5	7.7	7.4	8.4	7.6	7.3	8.4	7.6	7.2	8.2	7.4	7.1	7.6	7.1	6.7	159
165	8	7.4	7.3	8.2	7.4	7.3	8.2	7.4	7.2	8.1	7.4	7.1	8	7.3	7	7.3	6.9	6.6	165
171	7.6	7.2	7.2	7.9	7.3	7.1	7.9	7.2	7.1	7.9	7.2	7	7.7	7.1	6.9	7.1	6.8	6.5	171
177	7.2	7	7	7.6	7.1	7	7.7	7	7	7.7	7	6.9	7.5	6.9	6.8	6.8	6.6	6.4	177
183	6.9	6.7	6.9	7.3	6.9	7	7.4	6.9	6.9	7.5	6.8	6.8	7.3	6.8	6.7	6.6	6.5	6.3	183
189	6.5	6.4	6.6	7	6.7	6.8	7.1	6.7	6.8	7.2	6.7	6.7	7.1	6.6	6.6	6.3	6.3	6.2	189
195	6.1	6.2	6.4	6.6	6.5	6.7	6.8	6.6	6.7	7	6.6	6.6	6.9	6.5	6.5	6.1	6.1	6.1	195
207	5.5	5.6		6	6	6.2	6.1	6.2	6.4	6.5	6.3	6.5	6.5	6.2	6.4	5.5	5.7	5.8	207
219	4.9			5.5	5.5		5.5	5.6	5.8	5.9	5.9	6.2	6.1	6	6.2	4.9	5.1	5.4	219
231				4.9			4.9	5		5.3	5.4	5.6	5.2	5.7	5.9	4.3	4.6	4.8	231
243							4.3			4.8	4.9		4.1	5	5.2	3.7	4.1	4.3	243
255										4.3	4.5		3	3.8	3.8	2.7	3.5	3.8	255
267														2.6			2.4		267

TAB 172333 / 172340 / 172347

# Lifting heights Hauteurs de levage

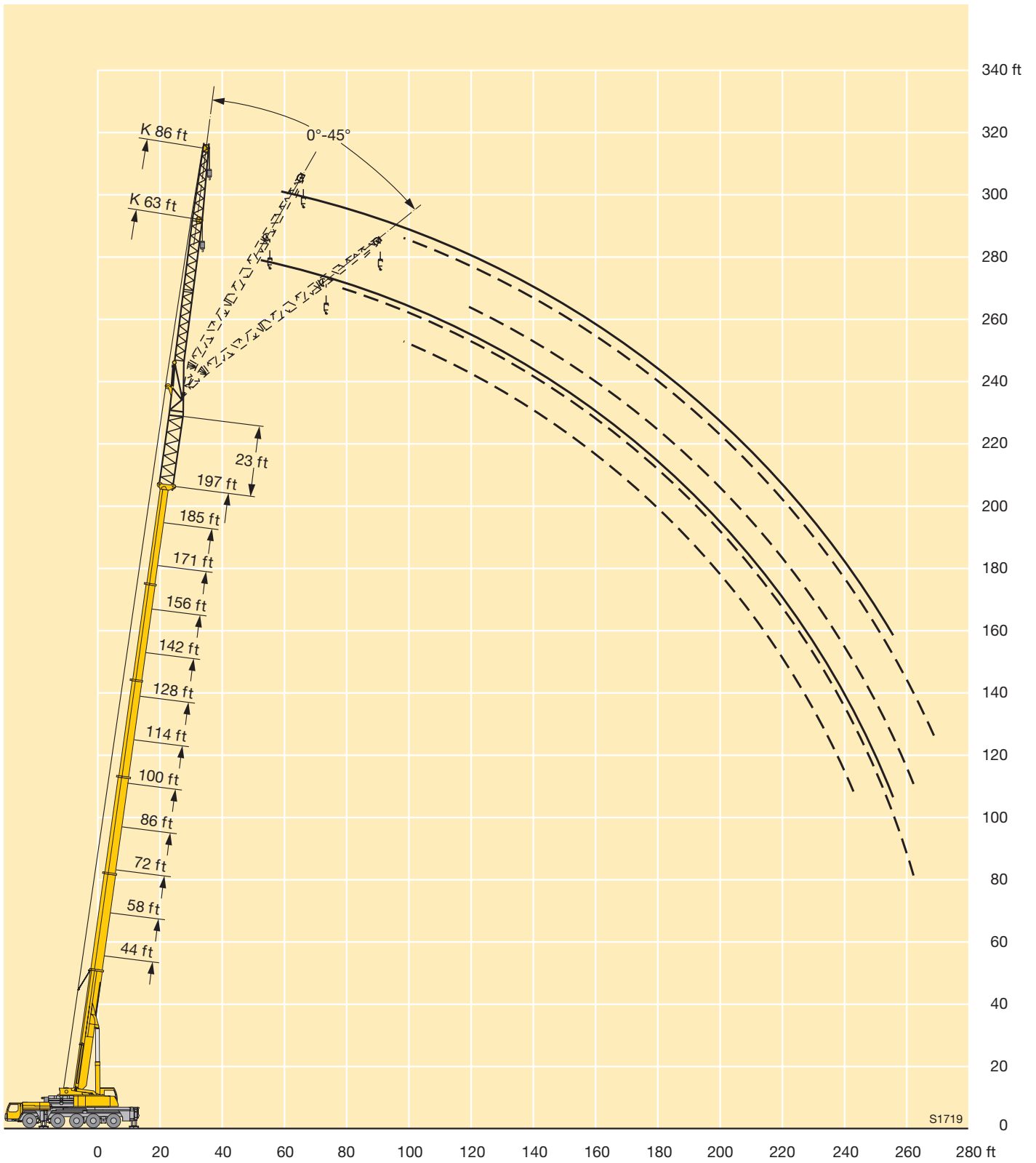

# Lifting capacities on the hydraulically variable folding jib with boom extension

## Capacités de levage à la flèche pliante à variation hydraulique avec télescope rallongé



ft	44 ft + 23 ft			58 ft + 23 ft			72 ft + 23 ft			86 ft + 23 ft			100 ft + 23 ft			114 ft + 23 ft			ft
	95 ft			95 ft			95 ft			95 ft			95 ft			95 ft			
	0°	22,5°	45°	0°	22,5°	45°	0°	22,5°	45°	0°	22,5°	45°	0°	22,5°	45°	0°	22,5°	45°	
18	17.2																		18
21	17.2			16.5															21
24	17.2			16.5			15.3												24
27	17.2			16.5			15.3			14.6									27
30	17.2			16.5			15.3			14.6			13.6						30
33	17.2			16.5			15.3			14.6			13.6						33
36	17.2			16.5			15.3			14.6			13.6			12.9			36
39	17.1			16.4			15.3			14.6			13.6			12.9			39
45	16.6			16.1			15.1			14.5			13.6			12.9			45
51	16			15.7			14.9			14.3			13.5			12.9			51
57	15.3	12.6		15.2	12.5		14.6			14.1			13.3			12.8			57
63	14.6	12.1		14.5	12.1		14.1	11.6		13.8			13.1			12.6			63
69	13.8	11.5		13.9	11.4		13.6	11.3		13.4	10.7		12.9	10.7		12.4			69
75	13.1	10.8		13.3	10.9		13	10.7		12.9	10.6		12.6	10.5		12.2	9.9		75
81	12.3	10.3	8	12.6	10.4	8.1	12.5	10.3		12.5	10.3		12.2	10.1		11.9	9.9		81
87	11.7	9.8	7.9	12	9.9	8	12	9.9	7.7	12	9.9		11.8	9.7		11.6	9.6		87
93	11	9.3	7.7	11.4	9.5	7.7	11.4	9.5	7.7	11.5	9.5	7.5	11.3	9.4	7.3	11.2	9.3		93
99	10.4	8.9	7.5	10.8	9	7.5	10.9	9.1	7.5	11.1	9.1	7.4	10.9	9.1	7.3	10.9	9	7	99
105	9.8	8.4	7.2	10.3	8.7	7.3	10.4	8.7	7.3	10.6	8.8	7.3	10.5	8.8	7.2	10.5	8.8	7	105
111	9.2	8.1	7.1	9.7	8.3	7.1	9.9	8.4	7.1	10.2	8.5	7.1	10.2	8.5	7.1	10.2	8.5	7	111
117	8.6	7.8	6.9	9.2	8	7	9.5	8.1	7	9.7	8.3	7	9.8	8.3	6.9	9.8	8.3	6.9	117
123	8.1	7.5	6.8	8.7	7.7	6.8	9	7.8	6.8	9.3	8	6.9	9.4	8	6.8	9.4	8	6.8	123
129	7.6	7.2	6.7	8.2	7.5	6.8	8.6	7.6	6.7	8.9	7.7	6.7	9	7.8	6.7	9.1	7.8	6.7	129
135	7.1	6.9	6.7	7.8	7.2	6.7	8.2	7.4	6.7	8.5	7.5	6.7	8.6	7.6	6.6	8.8	7.6	6.6	135
141	6.7	6.6		7.3	6.9	6.7	7.7	7.2	6.6	8.1	7.3	6.6	8.3	7.4	6.6	8.4	7.4	6.5	141
147	6.2	6.2		6.9	6.7	6.6	7.4	6.9	6.6	7.8	7.1	6.6	7.9	7.1	6.5	8.1	7.2	6.5	147
153				6.5	6.4		7	6.7	6.6	7.4	6.9	6.5	7.6	6.9	6.5	7.8	7.1	6.4	153
159				6.2	6.1		6.7	6.4		7	6.7	6.5	7.3	6.7	6.5	7.5	6.9	6.4	159
165							6.3	6.2		6.8	6.4	6.5	7	6.5	6.5	7.2	6.7	6.4	165
171							6	6		6.5	6.2		6.7	6.3	6.4	7	6.5	6.3	171
177							5.7	5.9		6.2	6		6.4	6.2	6.3	6.7	6.3	6.3	177
183										5.9	5.8		6.1	6	6.2	6.5	6.1	6.2	183
189										5.7	5.8		5.7	5.7		6.2	5.9	6.2	189
195													5.4	5.5		5.9	5.8	6.1	195
207													5			5.4	5.4		207
219																5.1			219

TAB 172333 / 172340 / 172347

# Lifting capacities on the hydraulically variable folding jib with boom extension

## Capacités de levage à la fléchette pliante à variation hydraulique avec télescope rallongé



ft	128 ft + 23 ft			142 ft + 23 ft			156 ft + 23 ft			171 ft + 23 ft			185 ft + 23 ft			197 ft + 23 ft			ft
	95 ft			95 ft			95 ft			95 ft			95 ft			95 ft			
	0°	22,5°	45°	0°	22,5°	45°	0°	22,5°	45°	0°	22,5°	45°	0°	22,5°	45°	0°	22,5°	45°	
39	11.9																		39
45	11.9			11.2			10.7												45
51	11.9			11.2			10.7			9.7			9						51
57	11.9			11.2			10.7			9.7			9			7.8			57
63	11.9			11.2			10.7			9.7			9			7.8			63
69	11.8			11.2			10.7			9.7			9			7.8			69
75	11.6	9.7		11.1			10.6			9.7			9			7.8			75
81	11.4	9.6		11	9.4		10.5			9.7			9			7.8			81
87	11.2	9.4		10.9	9.3		10.3	8.7		9.7	8.3		9			7.8			87
93	10.9	9.2		10.7	9.1		10.2	8.7		9.7	8.3		9	7.8		7.8			93
99	10.6	8.9	7.1	10.4	8.8		10.1	8.6		9.6	8.3		8.9	7.8		7.8	7		99
105	10.3	8.7	7.1	10.1	8.6		9.8	8.4		9.5	8.2		8.9	7.8		7.8	7		105
111	10	8.4	7	9.9	8.4	6.8	9.6	8.2	6.6	9.2	8		8.8	7.8		7.8	7		111
117	9.7	8.2	6.8	9.6	8.1	6.8	9.3	8	6.6	9	7.9	6.3	8.6	7.6		7.6	7		117
123	9.4	8	6.7	9.3	7.9	6.7	9	7.8	6.6	8.8	7.7	6.3	8.4	7.5		7.3	7		123
129	9	7.8	6.6	9	7.8	6.6	8.8	7.7	6.5	8.5	7.5	6.3	8.2	7.4	6.1	7.3	7	5.6	129
135	8.7	7.6	6.6	8.7	7.6	6.5	8.5	7.5	6.5	8.3	7.4	6.3	8	7.2	6.1	7.1	6.9	5.6	135
141	8.4	7.4	6.5	8.4	7.4	6.4	8.3	7.3	6.4	8.1	7.2	6.3	7.8	7.1	6.1	7	6.8	5.6	141
147	8.1	7.2	6.4	8.1	7.2	6.4	8.1	7.2	6.3	7.9	7.1	6.2	7.6	6.9	6.1	7	6.6	5.6	147
153	7.9	7	6.4	7.9	7.1	6.3	7.8	7	6.3	7.7	6.9	6.2	7.4	6.8	6.1	6.9	6.5	5.6	153
159	7.6	6.9	6.3	7.7	6.9	6.3	7.6	6.9	6.3	7.5	6.8	6.2	7.3	6.6	6.1	6.8	6.3	5.6	159
165	7.3	6.7	6.3	7.4	6.7	6.3	7.3	6.7	6.2	7.2	6.6	6.1	7.1	6.5	6	6.6	6.2	5.6	165
171	7	6.5	6.3	7.2	6.5	6.2	7.2	6.5	6.2	7	6.5	6.1	6.9	6.3	6	6.5	6.1	5.6	171
177	6.8	6.3	6.2	6.9	6.4	6.2	6.9	6.4	6.1	6.9	6.3	6.1	6.7	6.2	6	6.3	6	5.6	177
183	6.5	6.2	6.2	6.7	6.2	6.2	6.7	6.2	6.1	6.7	6.2	6	6.6	6.1	5.9	6.1	5.8	5.6	183
189	6.2	6	6.1	6.4	6.1	6.1	6.5	6.1	6	6.5	6	6	6.4	5.9	5.9	5.9	5.7	5.6	189
195	5.9	5.8	6	6.2	5.9	6	6.3	5.9	6	6.3	5.9	5.9	6.2	5.8	5.8	5.8	5.6	5.6	195
207	5.4	5.5		5.7	5.6	5.9	5.8	5.7	5.9	6	5.7	5.8	5.9	5.6	5.7	5.3	5.3	5.4	207
219	4.8	5		5.3	5.3		5.3	5.3	5.6	5.5	5.4	5.7	5.7	5.4	5.6	4.7	5	5.2	219
231				4.8	4.9		4.8	4.9	5.2	5.1	5.1	5.4	5.3	5.2	5.6	4.2	4.5	4.8	231
243							4.3	4.5		4.6	4.8	5	4.5	4.9	5.3	3.8	4.1	4.3	243
255							3.9	4		4.3	4.4		3.4	4.3	4.6	3	3.7	3.8	255
267										3.7	4		2.4	3.2			3		267

TAB 172333 / 172340 / 172347

# Lifting heights Hauteurs de levage

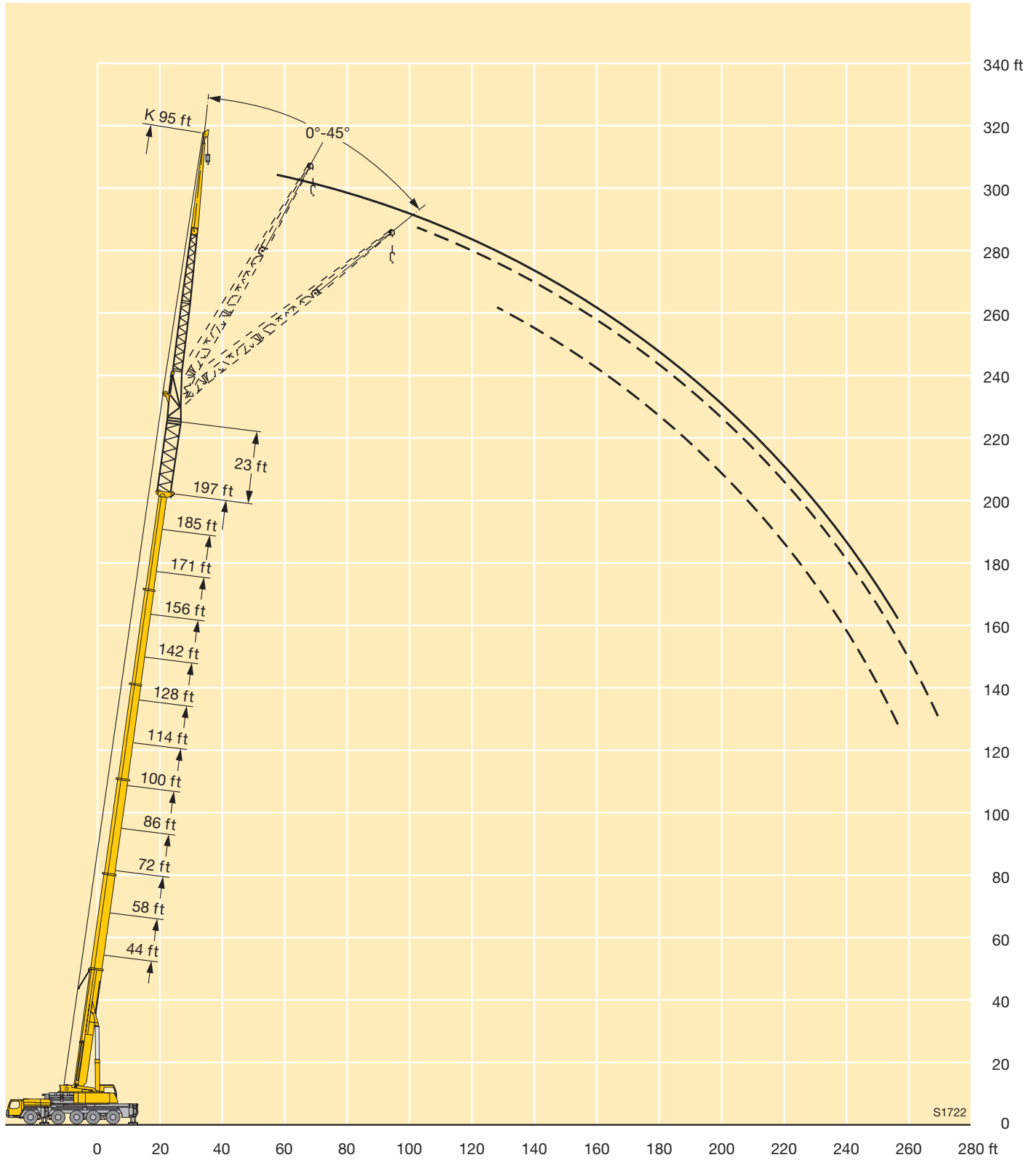

# Lifting capacities on the hydraulically variable folding jib with boom extension

## Capacités de levage à la fléchette pliante à variation hydraulique avec télescope rallongé



ft	44 ft + 23 ft			58 ft + 23 ft			72 ft + 23 ft			86 ft + 23 ft			100 ft + 23 ft			114 ft + 23 ft			ft
	118 ft			118 ft			118 ft			118 ft			118 ft			118 ft			
	0°	22,5°	45°	0°	22,5°	45°	0°	22,5°	45°	0°	22,5°	45°	0°	22,5°	45°	0°	22,5°	45°	
21	12.6																		21
24	12.6			11.9															24
27	12.6			11.9			10.9												27
30	12.6			11.9			10.9			10.4									30
33	12.6			11.9			10.9			10.4									33
36	12.6			11.9			10.9			10.4			9.7						36
39	12.6			11.9			10.9			10.4			9.7			9.2			39
45	12.3			11.8			10.9			10.4			9.7			9.2			45
51	11.9			11.5			10.8			10.4			9.7			9.2			51
57	11.4			11.1			10.6			10.3			9.7			9.2			57
63	10.8			10.7			10.3			10			9.5			9.2			63
69	10.3	8		10.2	8		9.9			9.7			9.2			9			69
75	9.7	7.8		9.7	7.8		9.5	7.3		9.3			9			8.7			75
81	9.2	7.4		9.2	7.3		9	7.2		9	6.9		8.7	6.8		8.5			81
87	8.6	7		8.8	7		8.6	6.9		8.6	6.8		8.4	6.7		8.2	6.3		87
93	8.1	6.6		8.3	6.6		8.2	6.5		8.2	6.5		8	6.4		8	6.3		93
99	7.6	6.2	4.8	7.8	6.3	4.8	7.9	6.2		7.9	6.2		7.7	6.1		7.7	6.1		99
105	7.2	5.9	4.8	7.4	6	4.8	7.5	6		7.5	6		7.4	5.9		7.4	5.8		105
111	6.7	5.6	4.6	7	5.7	4.6	7.1	5.7	4.6	7.2	5.7	4.6	7.1	5.6		7.1	5.6		111
117	6.3	5.3	4.5	6.6	5.4	4.5	6.7	5.5	4.4	6.9	5.5	4.5	6.8	5.4	4.4	6.8	5.4		117
123	6	5.1	4.4	6.3	5.2	4.4	6.4	5.2	4.4	6.6	5.3	4.4	6.6	5.2	4.3	6.6	5.2	4.3	123
129	5.6	4.8	4.2	5.9	5	4.3	6.1	5	4.3	6.3	5.1	4.3	6.3	5.1	4.2	6.4	5.1	4.2	129
135	5.3	4.7	4.1	5.6	4.8	4.2	5.8	4.8	4.2	6	4.9	4.2	6	4.9	4.1	6.1	4.9	4.1	135
141	4.9	4.5	4.1	5.3	4.6	4.1	5.5	4.7	4.1	5.7	4.7	4.1	5.8	4.8	4.1	5.9	4.8	4.1	141
147	4.6	4.3	4	5	4.5	4	5.3	4.5	4	5.5	4.6	4	5.6	4.6	4	5.6	4.6	4	147
153	4.4	4.2	4	4.8	4.3	4	5	4.4	4	5.2	4.5	4	5.3	4.5	3.9	5.4	4.5	3.9	153
159	4.1	4.1	4	4.5	4.2	4	4.8	4.3	3.9	5	4.3	3.9	5.1	4.4	3.9	5.2	4.4	3.9	159
165	3.9	4		4.3	4.1	4	4.6	4.2	3.9	4.8	4.2	3.9	4.9	4.3	3.9	5	4.3	3.8	165
171	3.7			4.1	4		4.4	4.1	3.9	4.6	4.1	3.9	4.8	4.2	3.8	4.8	4.2	3.8	171
177	3.5			3.8	4		4.2	4	3.9	4.4	4.1	3.9	4.6	4.1	3.8	4.7	4.1	3.8	177
183				3.7	3.9		4	3.9	3.9	4.3	4	3.9	4.5	4	3.8	4.5	4	3.8	183
189				3.6			3.8	3.9		4.1	3.9	3.9	4.3	3.9	3.8	4.4	4	3.8	189
195							3.7	3.9		4	3.9	3.9	4.2	3.9	3.8	4.3	3.9	3.8	195
207										3.7	3.8		3.9	3.8		4	3.8	3.8	207
219													3.6	3.7		3.8	3.7		219
231																3.6	3.6		231

TAB 172333 / 172340 / 172347

# Lifting capacities on the hydraulically variable folding jib with boom extension

## Capacités de levage à la fléchette pliante à variation hydraulique avec télescope rallongé



ft	128 ft + 23 ft			142 ft + 23 ft			156 ft + 23 ft			171 ft + 23 ft			185 ft + 23 ft			197 ft + 23 ft			ft
	118 ft			118 ft			118 ft			118 ft			118 ft			118 ft			
	0°	22,5°	45°	0°	22,5°	45°	0°	22,5°	45°	0°	22,5°	45°	0°	22,5°	45°	0°	22,5°	45°	
45	8.3			8						6.6									45
51	8.3			8			7.5			6.6									51
57	8.3			8			7.5			6.6			5.8						57
63	8.3			8			7.5			6.6			5.8						63
69	8.3			8			7.5			6.6			5.8			4.6			69
75	8.2			8			7.5			6.6			5.8			4.6			75
81	8.1			7.9			7.4			6.6			5.8			4.6			81
87	7.9	6.1		7.7			7.3			6.6			5.8			4.6			87
93	7.7	6.1		7.5	5.8		7.1			6.6			5.8			4.6			93
99	7.5	6		7.2	5.8		6.9	5.3		6.5	5.1		5.8			4.6			99
105	7.2	5.7		7	5.6		6.8	5.3		6.5	5.1		5.8			4.6			105
111	7	5.5		6.8	5.5		6.6	5.3		6.3	5.1		5.8	4.6		4.6			111
117	6.7	5.4		6.6	5.3		6.4	5.2		6.2	4.9		5.8	4.6		4.6	4.1		117
123	6.5	5.2	4.1	6.4	5.1		6.2	5.1		6.1	4.9		5.7	4.6		4.6	4.1		123
129	6.3	5	4.1	6.2	5	4.1	6.1	4.9	3.9	5.9	4.8		5.6	4.6		4.6	4.1		129
135	6.1	4.9	4.1	6	4.9	4.1	5.9	4.8	3.9	5.7	4.7	3.6	5.4	4.6		4.6	4.1		135
141	5.8	4.8	4	5.8	4.7	4	5.7	4.7	3.9	5.6	4.6	3.6	5.3	4.5	3.6	4.6	4.1		141
147	5.6	4.6	3.9	5.6	4.6	3.9	5.5	4.6	3.9	5.4	4.5	3.6	5.2	4.4	3.6	4.6	4.1	3.5	147
153	5.4	4.5	3.9	5.5	4.5	3.9	5.4	4.5	3.8	5.3	4.4	3.6	5.1	4.3	3.6	4.6	4.1	3.5	153
159	5.2	4.4	3.9	5.3	4.4	3.8	5.2	4.4	3.8	5.1	4.3	3.6	5	4.3	3.6	4.6	4.1	3.5	159
165	5.1	4.3	3.8	5.1	4.3	3.8	5	4.3	3.8	5	4.2	3.6	4.8	4.2	3.6	4.6	4	3.5	165
171	4.9	4.2	3.8	4.9	4.2	3.8	4.9	4.2	3.7	4.9	4.2	3.6	4.7	4.1	3.6	4.5	3.9	3.5	171
177	4.8	4.1	3.8	4.8	4.1	3.7	4.7	4.1	3.7	4.7	4.1	3.6	4.6	4	3.6	4.4	3.9	3.5	177
183	4.6	4	3.7	4.7	4	3.7	4.6	4	3.7	4.6	4	3.6	4.5	3.9	3.4	4.3	3.8	3.5	183
189	4.4	4	3.7	4.6	4	3.7	4.5	4	3.6	4.5	3.9	3.6	4.4	3.9	3.4	4.2	3.8	3.4	189
195	4.3	3.9	3.7	4.4	3.9	3.7	4.4	3.9	3.6	4.4	3.9	3.6	4.3	3.8	3.4	4.1	3.7	3.4	195
207	4.1	3.8	3.7	4.2	3.8	3.7	4.2	3.8	3.6	4.2	3.7	3.6	4.1	3.7	3.4	4	3.6	3.4	207
219	3.8	3.7	3.7	3.9	3.7	3.7	4	3.7	3.6	3.9	3.6	3.6	3.9	3.6	3.4	3.7	3.5	3.4	219
231	3.6	3.6		3.7	3.6	3.7	3.7	3.6	3.6	3.8	3.6	3.6	3.8	3.5	3.4	3.3	3.4	3.3	231
243	3.2	3.4		3.5	3.5		3.5	3.5	3.6	3.6	3.4	3.6	3.6	3.4	3.4	2.9	3.2	3.2	243
255				3.2	3.3		3.3	3.4	3.6	3.4	3.4	3.6	3.4	3.3	3.4	2.5	2.9	3.1	255
267				3			2.9	3.1		3.2	3.3	3.5	2.5	3.2	3.4		2.6	2.8	267
279										2.8	3.1			2.6	2.8			2.3	279

TAB 172333 / 172340 / 172347

# Lifting heights Hauteurs de levage

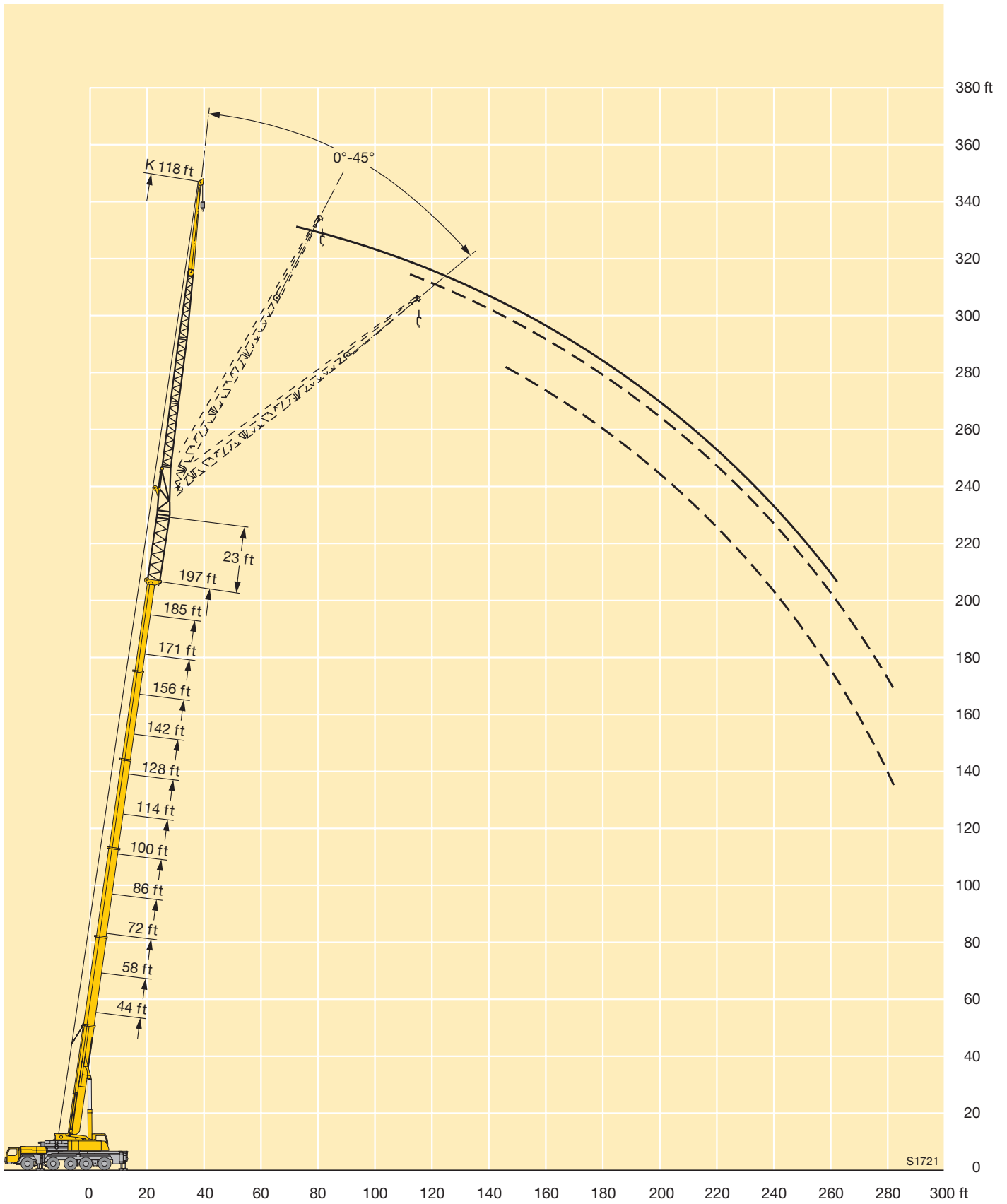

# Dimensions Encombrement

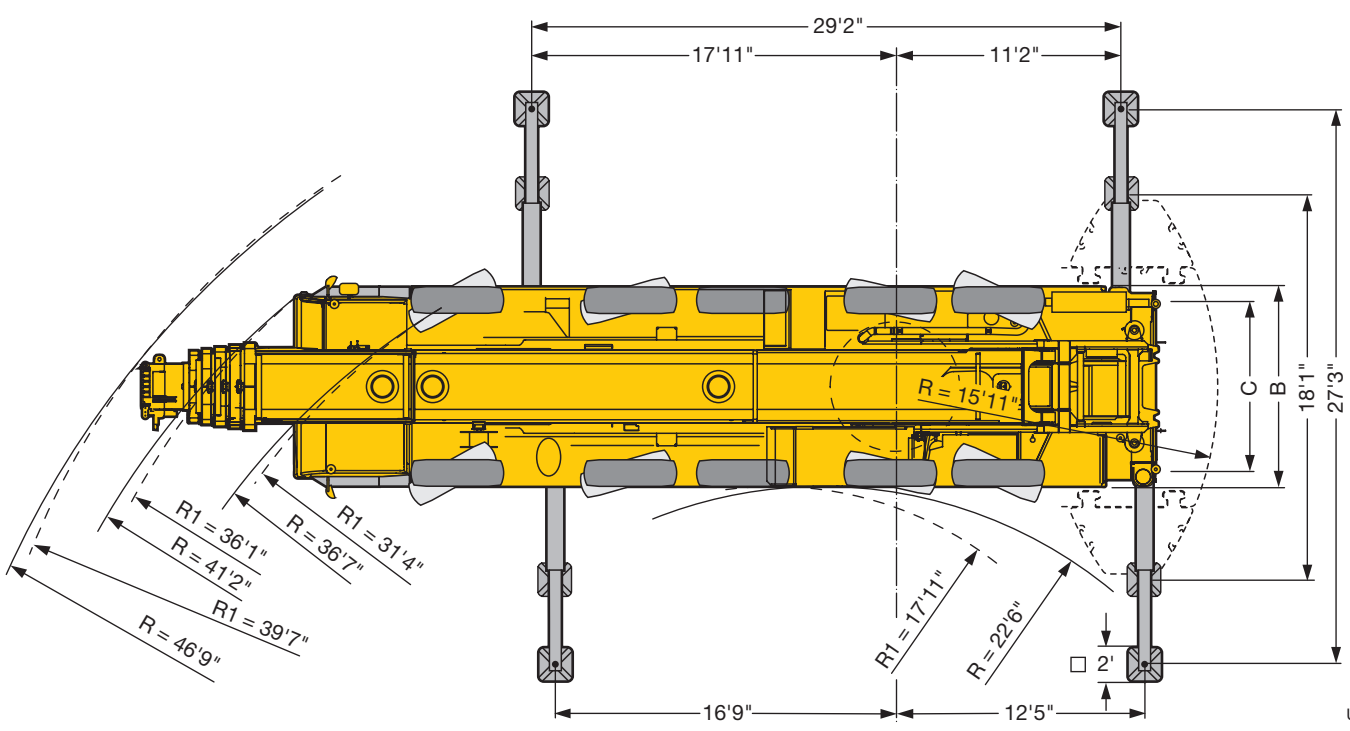
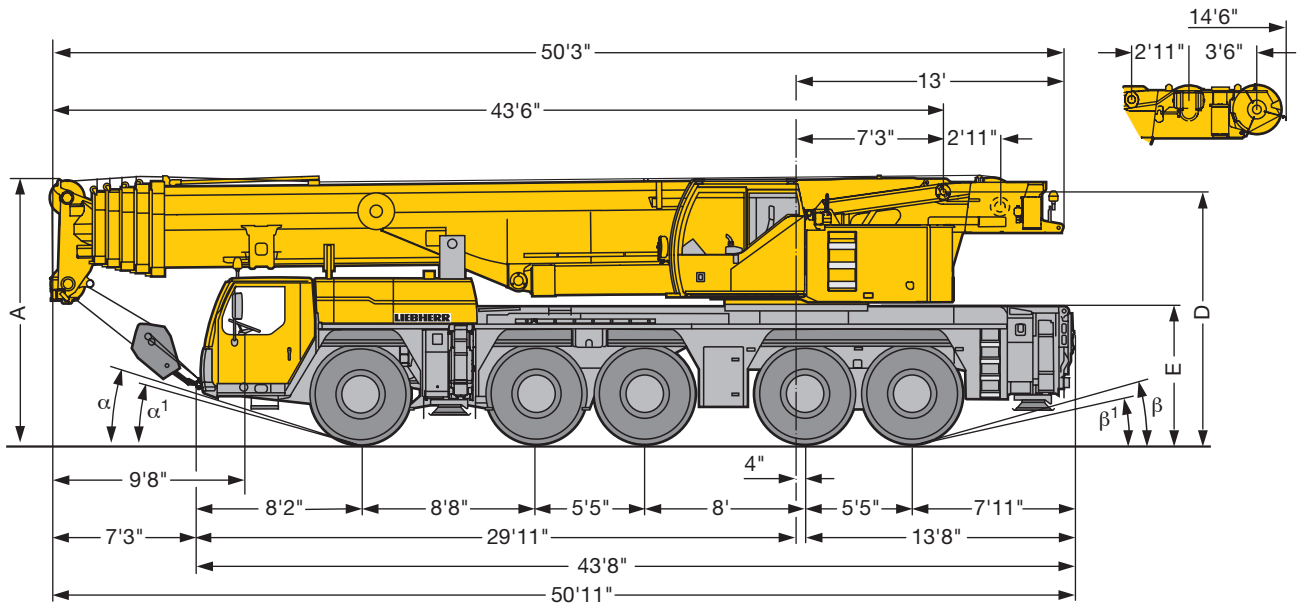

US1969

R<sub>1</sub> = All-wheel steering · Direction toutes roues

		Dimensions / Encombrement									
		A	A 6" *	B	C	D	E	α	α <sub>1</sub>	β	β <sub>1</sub>
16.00	R 25	13'1"	12'8"	9'10"	8'4"	12'4"	6'9"	20°	16°	17°	14°
20.5	R 25	13'1"	12'8"	10'2"	8'5"	12'4"	6'9"	20°	16°	17°	14°

\* lowered / abaissé

## Weights Poids



Axle Essieu	1	2	3	4	5	Total weight (lbs) Poids total lbs
lbs	26400	26400	26400	26400	26400	132000



Load (kips) Forces de levage kips	No. of sheaves Poulies	No. of lines Brins	Weight lbs Poids lbs
332.9	9	16	4400
314.4	7	15	3300
237.4	5	11	2866
155.6	3	7	2292
68.7	1	3	1851
23.1	-	1	1102

## Working speeds Vitesses



		1	2	3	4	5	6	7	8	9	10	11	12	R1	R2	
16.00 R 25	mph	3.5	4.5	5.8	7.5	9.5	12.2	16.1	20.6	26.6	34.2	43.4	50	3.8	4.9	43 %
20.5 R 25		1.6	2	2.6	3.3	4.2	5.3	7	9	11.6	14.9	19.5	24.2	1.7	2.1	56 %



Drive Mécanismes	infinitely variable en continu	Rope diameter / Rope length Diamètre du câble / Longueur du câble	Max. single line pull Effort au brin maxi.
	0 – 426 ft/min single line ft/min au brin simple	0.8" / 920 ft	23605 lbs
	0 – 426 ft/min single line ft/min au brin simple	0.8" / 920 ft	23605 lbs
	0 – 1.8 rpm		
	approx. 50 seconds to reach 82° boom angle env. 50 s jusqu'à 82°		
	approx. 360 seconds for boom extension from 44 ft – 197 ft env. 360 s pour passer de 44 ft – 197 ft		

## Equipment Équipement

### Crane carrier

<b>Frame</b>	Self-manufactured, weight-optimized and torsion resistant box-type design of high-tensile structural steel.
<b>Outriggers</b>	4-point supporting system, hydraulically telescopic into horizontal and vertical direction. Automatic levelling of crane. Electronic inclination indicator.
<b>Engine</b>	6-cylinder Diesel, make Liebherr, type D846 A7, watercooled, output 370 kW (503 h.p.) at 1900 rpm, max. torque 1734 lbs-ft at 1200 – 1500 rpm. Exhaust emissions acc. to 97/68/EG stage 3 and EPA/CARB Tier 3. Fuel reservoir: 129 gallons.
<b>Transmission</b>	ZF 12-speed gear box with automatic control system AS-TRONIC. ZF-intarder fitted directly to the gear. Two-stage transfer case with lockable transfer differential.
<b>Axles</b>	Welded design, made of high-tensile fine grained steel. All axles steerable. Axles 2, 4 and 5 are planetary axles with differential locks.
<b>Suspension</b>	All axles are mounted on hydropneumatic suspension – “Niveaumatik suspension” and are lockable hydraulically.
<b>Tyres</b>	10 tyres, size: 16.00 R 25.
<b>Steering</b>	ZF-servocom power steering, dual circuit system with hydraulic servo system and auxiliary pump system, driven by the axle. At road displacement, axles 3, 4 and 5 electrohydraulically speed-dependent and from 18.6 mph, axles 3 and 4 are fixed to straight displacement. From 37.3 mph, axle 5 is fixed straight. Steering according to EG directive 70/311 EWG.
<b>Brakes</b>	Service brake: all-wheel servo-air brake, all axles are equipped with disc brakes, dual circuit. Parking brake: Spring brake actuator, acting on the wheels of the 2 <sup>nd</sup> and 5 <sup>th</sup> axle. Sustained-action brakes: Engine brake as exhaust retarder with Liebherr additional brake system ZBS. Intarder on gear. Brakes acc. to EG directives 71/320 EWG.
<b>Driver's cab</b>	Spacious, steel made, corrosion resistant cab, cataphoretic dip-primed, on resilient suspension with hydraulic shock absorbers, sound and heat absorbing internal panelling acc. to EG directive, safety glazing, operating and control instruments, comfortably equipped.
<b>Electrical system</b>	Modern data bus technique, 24 Volt DC, 2 batteries of 170 Ah each, lighting acc. to traffic regulations.

### Crane superstructure

<b>Frame</b>	Self-manufactured, weight-optimized and torsion resistant welded design of high-tensile structural steel; linked by a triple-row roller slewing rim to the carrier for continuous rotation.
<b>Crane engine</b>	4-cylinder Diesel, make Liebherr, type D934L A6, watercooled, output 180 kW (245 h.p.) at 1800 rpm, max. torque 839 lbs-ft at 1500 rpm. Exhaust emissions acc. to 97/68/EG stage 3 and EPA/CARB Tier 3. Fuel reservoir: 70 gallons.
<b>Crane drive</b>	Diesel-hydraulic, with 5 axial piston variable displacement pumps, with servo-control and capacity control, 1 double gear pump. Compact hydraulic drive flanged to the Diesel engine. Drive assembly completely enclosed for noise abatement.
<b>Control</b>	Electronic control by the LICCON computer system (PLC control), two self-centering control levers (joy-sticks). Infinitely variable crane motions through displacement control of the hydraulic pump. Additional working speed control by variation of the Diesel engine.
<b>Hoist gear</b>	Axial piston variable displacement motor, Liebherr hoist drum with integrated planetary gear and spring-loaded static brake. Actuation by closed regulated oil circuit.
<b>Luffing gear</b>	1 differential ram with nonreturn valve.
<b>Slewing gear</b>	Axial piston fixed displacement motor, planetary gear, spring-loaded static brake.
<b>Crane cab</b>	All-steel construction, entirely galvanized, powder coated, with safety glazing, operating and control instruments, comfortably equipped, cab tiltable backwards.
<b>Safety devices</b>	LICCON safe load indicator, test system, hoist limit switch, safety valves to prevent pipe and hose ruptures.
<b>Telescopic boom</b>	Buckling and torsion resistant design of high-tensile structural steel, oviform boom profile, 1 base section and 5 telescopic sections. All telescopic sections hydraulically extendable independent of one another. Rapid-cycle telescoping system „Telematik“. Boom length: 44 ft – 197 ft.
<b>Counterweight</b>	163100 lbs
<b>Electrical system</b>	Modern data bus technique, 24 Volt DC, 2 batteries of 170 Ah each.

### Additional equipment

<b>Swing-away jib</b>	40 ft – 118 ft long, mountable to the telescopic boom at 0°, 22,5° or 45°. Hydraulic ram for operating the swing-away jib from 0° – 45° (option).
<b>Telescopic boom extension</b>	23 ft long lattice section, thus 23 ft higher pinning point for swing-away jib.
<b>2<sup>nd</sup> hoist gear</b>	For two-hook operation or for operation with swing-away jib if the hoist rope shall remain reeved.
<b>Tyres</b>	10 tyres, size 20.5 R 25.
<b>Drive 10 x 8</b>	Additional drive of the 2nd axle.

Other items of equipment available on request.

## Equipment Equipement

### Châssis porteur

<b>Cadre</b>	Construction en caisse résistante à la torsion et optimisée en poids réalisée par Liebherr en acier de construction à grain fin très rigide.
<b>Calage</b>	Dispositif de calage horizontal et vertical en 4 points, entièrement déployable hydrauliquement. Nivellement automatique du calage. Indicateurs électroniques d'inclinaison.
<b>Moteur</b>	Moteur diesel, 6 cylindres, fabriqué par Liebherr, de type D846 A7, à refroidissement par eau, de 370 kW (503 ch) à 1900 rpm, couple max. 1734 lbs-ft à 1200 – 1500 rpm. Emissions des gaz d'échappement conformes aux directives 97/68/EG partie 3 et EPA/CARB Tier 3. Capacité du réservoir à carburant: 129 gallons.
<b>Boîte de vitesse</b>	Boîte de vitesses ZF à 12 rapports, mécanisme automatisé à commande AS-TRONIC. Ralentisseur hydrodynamique ZF directement accouplé à la boîte. Boîte de transfert à 2 étages avec blocage de différentiel.
<b>Essieux</b>	Construction soudée en acier haute résistance à grains fins pour l'ensemble des 5 essieux. Tous les essieux sont directeurs. Essieux 2, 4 et 5 planétaires avec blocage du différentiel.
<b>Suspension</b>	Suspension hydropneumatique «Niveaumatik» - sur tous les essieux. Chaque essieu peut être bloqué hydrauliquement.
<b>Pneumatiques</b>	10 pneus de taille: 16.00 R 25.
<b>Direction</b>	Direction hydraulique ZF Servocom, à 2 circuits, assistée hydrauliquement, avec pompe auxiliaire entraînée par essieu. Lors de déplacements sur route, les essieux 3, 4 et 5 sont dirigés électrohydrauliquement en fonction de la vitesse, et à partir de 18,6 mph, les essieux 3 et 4 sont fixés en marche rectiligne. A partir d'env. 37,3 mph, l'essieu 5 est fixé en marche rectiligne. Direction conforme aux directives européennes 70/311 CE.
<b>Freins</b>	Freins de service: servofrein à air comprimé, tous les essieux sont munis de freins à disque, à 2 circuits. Frein à main: ressort accumulé agissant sur les roues des essieux 2 à 5. Freins continus: frein moteur par clapet sur échappement avec système de ralentissement Liebherr ZBS. Ralentisseur hydrodynamique accouplé à la boîte de vitesses. Freins conformes aux directives européennes 71/320 CE.
<b>Cabine du conducteur</b>	Cabine spacieuse en tôle d'acier traitement anti-corrosion par bain de cataphorèse, avec suspension élastique et amortisseurs hydrauliques, revêtement intérieur avec isolation phonique et thermique selon les directives européennes, glaces de sécurité, appareils de commande et de contrôle, équipement confortable.
<b>Installation électrique</b>	Technique moderne de transmission de données par BUS de données, courant continu 24 Volts, 2 batteries de 170 Ah chacune, éclairage conforme au code de la route.

### Partie tournante

<b>Cadre</b>	Construction soudée résistante à la torsion et optimisée en poids réalisée par Liebherr en acier de construction à grain fin très rigide. Couronne d'orientation à rouleaux à 3 rangées permettant une rotation illimitée sert de pièce de liaison avec le châssis de la grue.
--------------	--

<b>Moteur</b>	Moteur diesel Liebherr, 4 cylindres, de type D934L A6, à refroidissement par eau, de 180 kW (245 ch) à 1800 rpm, couple max. 839 lbs-ft à 1500 rpm. Emissions des gaz d'échappement conformes aux directives 97/68/EG partie 3 et EPA/CARB Tier 3. Capacité du réservoir à carburant: 70 gallons.
<b>Entraînement de la grue</b>	Diesel hydraulique avec 5 pompes à débit variable à pistons axiaux, servocommande et régulation de la puissance, 1 double pompe à engrenages. Entraînement hydraulique compact, accouplé directement au moteur Diesel, mécanisme d'entraînement total fermé pour une bonne insonorisation.
<b>Commande</b>	Commande électronique par l'ordinateur LICCON (commande SPS). 2 leviers à 4 directions avec rappel automatique au point mort. Commande des mouvements progressive en continu par variation de l'inclinaison des pompes et augmentation du régime moteur.
<b>Mécanisme de levage</b>	Moteur hydraulique à cylindrée variable, treuil de marque Liebherr avec réducteur planétaire à frein d'arrêt à lamelles intégrées, en circuit hydraulique fermé.
<b>Mécanisme de relevage</b>	1 vérin hydraulique différentiel avec clapets anti-retour de sécurité.
<b>Dispositif de rotation</b>	Moteur à cylindrée constante à pistons axiaux, engrenage planétaire, frein d'arrêt commandé par ressort.
<b>Cabine du grutier</b>	Construction en tôle d'acier entièrement zinguée avec peinture par poudrage et cuisson au four, avec glaces de sécurité, appareils de commande et de contrôle, équipement confortable. Cabine inclinable vers l'arrière.
<b>Dispositif de sécurité</b>	Contrôleur de charge, „LICCON“, système test, limitation de la course pour le levage, soupape de sûreté contre la rupture de tubes et de tuyaux.
<b>Flèche télescopique</b>	Flèche télescopique en acier à haute résistance à grains fins, à profil ovale, 1 élément de base et 5 éléments télescopiques. Tous les éléments télescopiques indépendamment les uns des autres. Système de télescopage séquentiel rapide, „Telematik“. Longueur de flèche: 44 ft – 197 ft.
<b>Contrepoids</b>	163100 lbs
<b>Installation électrique</b>	Technique moderne de transmission de données. Courant continu 24 Volts, 2 batteries de 170 Ah chacune.

### Equipement supplémentaire

<b>Fléchette pliante</b>	Longueur: 40 ft – 118 ft, montable sous un angle de 0°, 22,5° ou 45°. Vérin hydraulique pour le relevage de la fléchette pliante de 0° à 45° (en option).
<b>Rallonge flèche télescopique</b>	Élément en treillis de 23 ft, de cette manière point d'articulation plus haute de 23 ft pour la flèche pliante.
<b>2ème mécanisme de levage</b>	Pour l'utilisation du deuxième crochet, ou bien pour une utilisation avec fléchette pliante lorsque le câble de levage principal rest mouflé.
<b>Pneumatiques</b>	10 pneus. Taille: 20.5 R 25.
<b>Entraînement 10 x 8</b>	Essieu 2 est entraîné additionnellement.

Autres équipements supplémentaires sur demande.

## Remarks referring to load charts

1. The tabulated lifting capacities do not exceed 85% of the tipping load.
2. The crane's structural steelwork is in accordance with DIN 15018, part 3. Design and construction of the crane comply with DIN 15018, part 2, and with F. E. M. regulations.
3. The 85% overturning limit values take into account wind force 5 = wind speed 20 mph.
4. Lifting capacities are given in kips.
5. The weight of the hook blocks and hooks must be deducted from the lifting capacities.
6. Working radii are measured from the slewing centreline.
7. The lifting capacities given for the telescopic boom only apply if the folding jib is taken off.
8. Lifting capacities are subject to modifications.
9. Lifting capacities above 298 kips / 332.9 kips only with additional pulley block/special equipment.

## Remarques relatives aux tableaux des charges

1. Les forces de levage indiquées ne dépassent pas 85% de la charge de basculement.
2. La norme DIN 15018, 3ème partie est appliquée pour les charpentes. La construction de la grue est réalisée conformément à la norme DIN 15018, 2ème partie, et aux règles de la F. E. M.
3. A 85% de la charge de basculement, il a été tenu compte d'un vent de force 5 = vitesse de vent 20 mph.
4. Les forces de levage sont données en kips.
5. Les poids des moufles et crochets doit être soustrait des charges indiquées.
6. Les portées sont calculées à partir de l'axe de rotation.
7. Les forces indiquées pour la flèche télescopique s'entendent fléchette dépliée déposée.
8. Les forces de levage sont modifiables sans préavis.
9. Forces de levage plus de 298 kips / 332.9 kips seulement avec moufle additionnel/équipement supplémentaire.